

WASKO®

Displays International



2012

INDEX

POP UP DISPLAYS 3

DESIGN COUNTERS 5

CLASSIC COUNTERS 9

BANNER DISPLAY STANDS 11

ROLL UP BANNER STANDS 19

SCROLLING BANNER STANDS 29

MEDIA PRODUCTS 30

POSTER STANDS 31

SHELVES 34

PROFILES 36

BAMBOO LINE 37

OUTDOORS 39

SIZE/MEASURES 43

NOTES

KEEP CONTACT!



POP UP DISPLAYS



POP UP FLORENCE

Item No: PC FLO 43
Pop up 4 x 3 curved
Graphic size:
3992mmWx2380mmH

Item No: PC FLO 33
Pop up 3 x 3 curved
Graphic size:
3244mmWx2380mmH

Material: Aluminium & Steel
N.W.:43,0kg
G.W.:46,5kg
Curved self locking frame
Connected magnetic bars
2 spotlights - magnetic tape
Hard case trolley + wooden table



POP UP DISPLAY

Material: Aluminium, Steel, PVC
Finish: Oxidative/Painting
Color: Silver/Black



4X3 CURVED

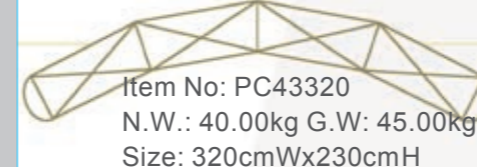

Item No: PC43320
N.W.: 40.00kg G.W: 45.00kg
Size: 320cmWx230cmH

4X3 STRAIGHT

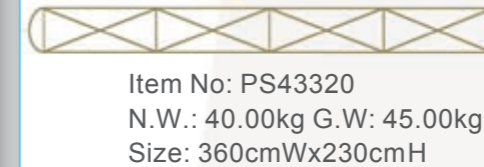

Item No: PS43320
N.W.: 40.00kg G.W: 45.00kg
Size: 360cmWx230cmH

3X3 CURVED

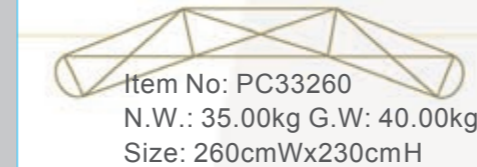

Item No: PC33260
N.W.: 35.00kg G.W: 40.00kg
Size: 260cmWx230cmH

3X3 STRAIGHT

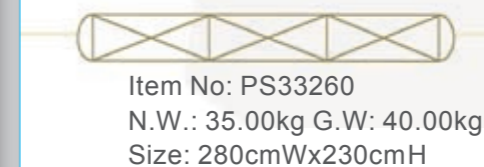

Item No: PS33260
N.W.: 35.00kg G.W: 40.00kg
Size: 280cmWx230cmH

LITE POP UP

Item No: HK 10A
Material: Aluminium
N.W.: 15.3kg G.W: 16.8kg
Size: 283cmWx225cmH



POP UP CARPET

Item No: PCC 43320
Fits with our standard pop-up
PC 43320

Item No: PCC 33260
Fits with our standard pop-up
PC 33260

Carpets supplied with
magnetic tape, ready for use

DESIGN COUNTERS

PROMO DESK

Item No: PDK-500
 Wooden top size: 90,5cmx45cm
 Wooden shelf
 Graphic size: 90cmWx180cmH

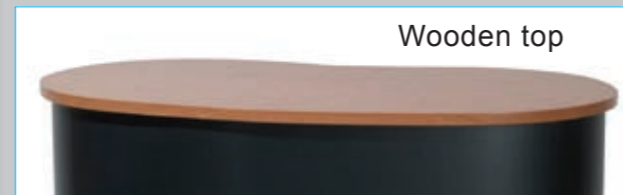

Wooden top

PROMO DESK

Item No: PDK-700
 Two poles and panel
 Wooden top
 Wooden shelf
 Graphic size desk: 90cmWx180cmH
 Graphic Panel size: 71cmx27cm

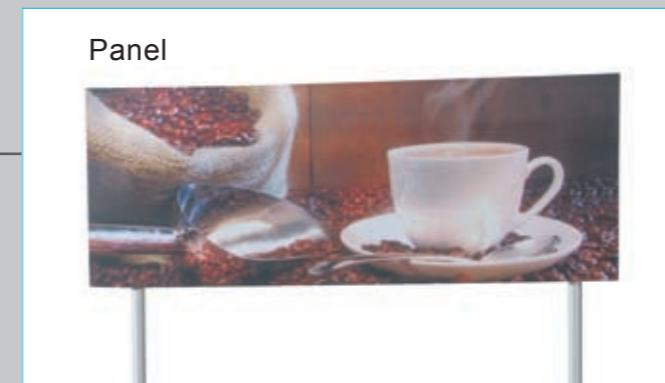

Panel



TWISTER PROMO DESK

Item No: LD-TWD-10
Aluminium frame
Wooden table top
Acrylic shelf, 4 pillars
PVC sheet for pictures
Oxford trolley bag
Size: Ø 50cmx106cm



Twister system



Oxford trolley bag



SPIRALY LINE



TWISTER SHOWCASE TOWER

Item No: LD-TWT-100
Material: Aluminium frame coated with plastic
Acrylic shelf, 4 pillars
PVC sheet for pictures
110v/220v
Oxford trolley bag
Size: Ø 50cmx206cm



SEMI-CIRCLE TWISTER SHOWCASE

Item No: LD-TWT-50
Aluminium frame coated with plastic
Acrylic shelf, 4 pillars
PVC sheet for pictures
110v/220v
Oxford trolley bag
Size: Ø 50cmx206cm



CLASSIC COUNTERS



PROMOTION TABLE

Item No: CP01080
 Material: PVC
 Color: White
 N.W.: 8.00kg
 G.W.: 9.00kg
 Size: 85cmx53cmx220cm



POP UP COUNTER

Item No: CU-4500/CL
 Aluminium pop up frame
 Magnetic clip bars
 Natural wooden table
 Natural wooden shelves (4pcs)
 Trolley bag
 Graphic size: 88cmx243cm



POP UP TABLE

Item No: CU04150
 Material: Aluminium, PVC
 Color: Silver/Black
 N.W.: 18.00kg
 G.W.: 20.00kg
 Size: 128cmWx97cmH



POP UP TABLE WITH TROLLEY

Item No: CU04150-TR
 Material: Aluminium, PVC
 Color: Silver/Black
 N.W.: 18.00kg
 G.W.: 20.00kg
 Size: 128cmWx97cmH

BANNER DISPLAY STANDS



X-PAND STAND

Item No: PE05085
 Material: Aluminium, Steel
 Finish: Oxidative/Painting
 Color: Silver/Black
 N.W.: 2.70kg
 G.W.: 3.60kg
 Graphic size: 90cmx218cm

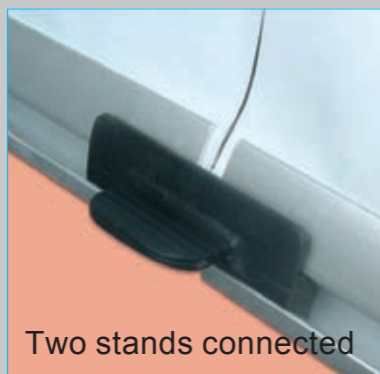

Two stands connected



BANNER DISPLAY "APOLO"

Item No: BAN-SH3
 Material: Aluminium & steel
 2 in 1 banner display
 3 magazine rack
 Graphic size: 60cmx180cm

L-BANNER L5

Item No: YC-L5
 Material: Aluminium
 Color: Silver/Black
 N.W.: 2.4kg
 G.W.: 23.6kg
 Sizes: 60cmWx180cmH
 80cmWx200cmH
 90cmWx200cmH
 Banner Spotlight - Optional



L-BANNER L5 DOUBLE SIDED

Item No: YC-L5A
 Material: Aluminium
 Color: Silver/Black
 N.W.: 3.5kg
 G.W.: 33.5kg
 Sizes:
 60cmWx180cmH
 90cmWx200cmH
 Banner Spotlight - Optional

**BANNER STAND
"MIKOS LINE" SINGLE SIDED**

Item No: MIK-100/S
Material: Aluminium
Color: Silver
Adjustable height
Graphic size: 60cmWx180cmH
80cmWx180cmH
Packing: 10 pcs/ctn.
Optional: Mini spot

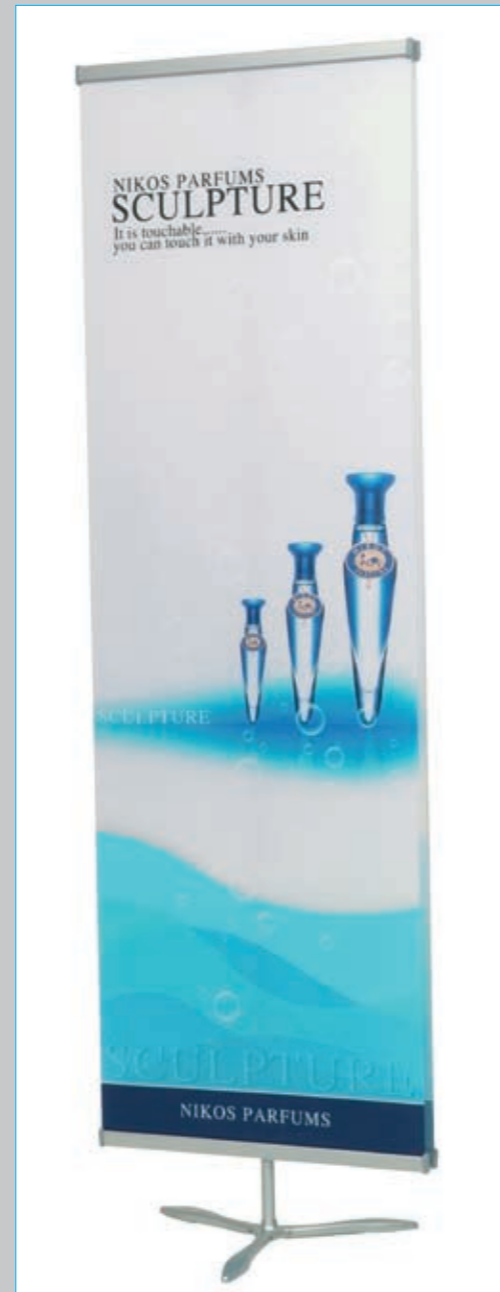
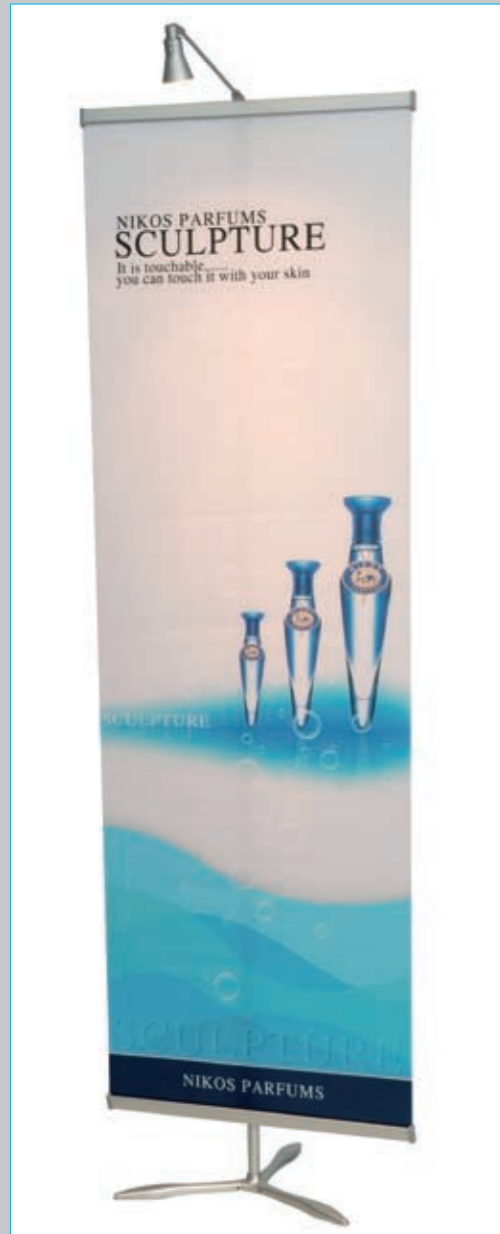

**BANNER STAND
"MIKOS LINE" DOUBLE SIDED**

Item No: MIK-100/D
Material: Aluminium
Color: Silver
Adjustable height
Graphic size: 60cmWx180cmH
80cmWx180cmH
Packing: 10 pcs/ctn.



MIKOS LINE

**BANNER STAND "MIKOS LINE"
SINGLE SIDED: REF MIK-500/S
DOUBLE SIDED: REF MIK-500/D**

Item No: MIK-500/S (single sided)
Item No: MIK-500/D (double sided)
Material: Aluminium
Color: Silver
Adjustable height
Graphic size: 90cmWx180cmH
Packing: 10 pcs/ctn.
Optional: Mini spot

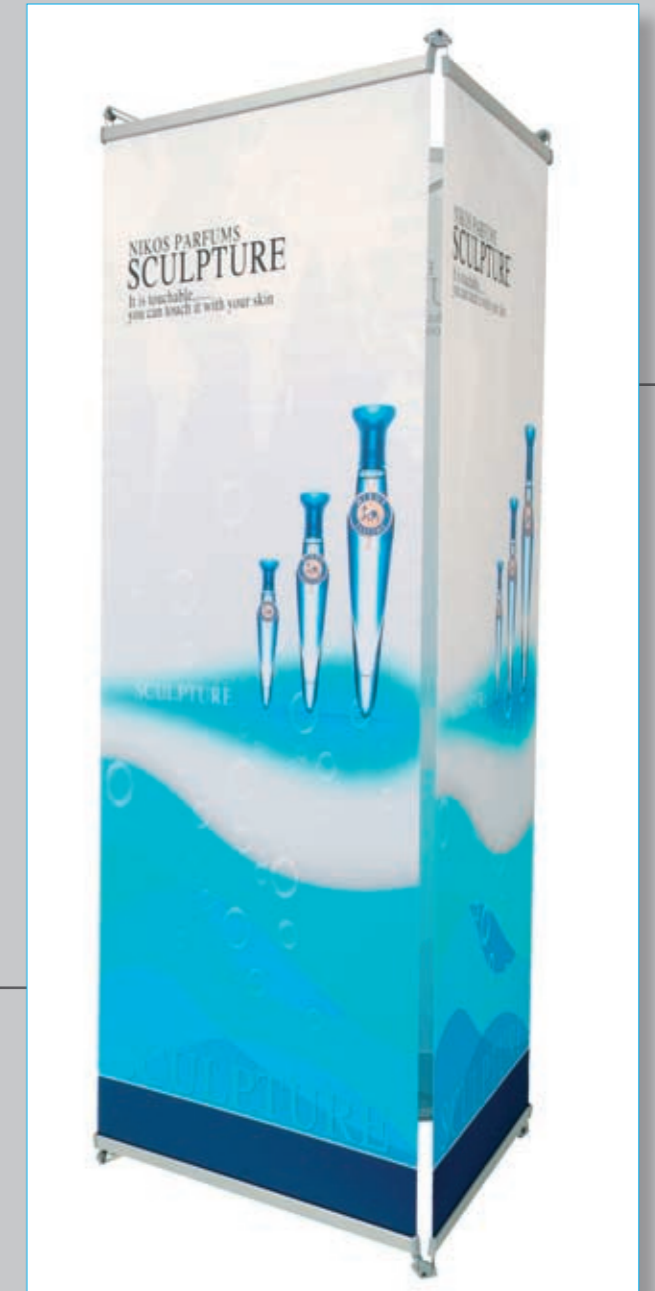
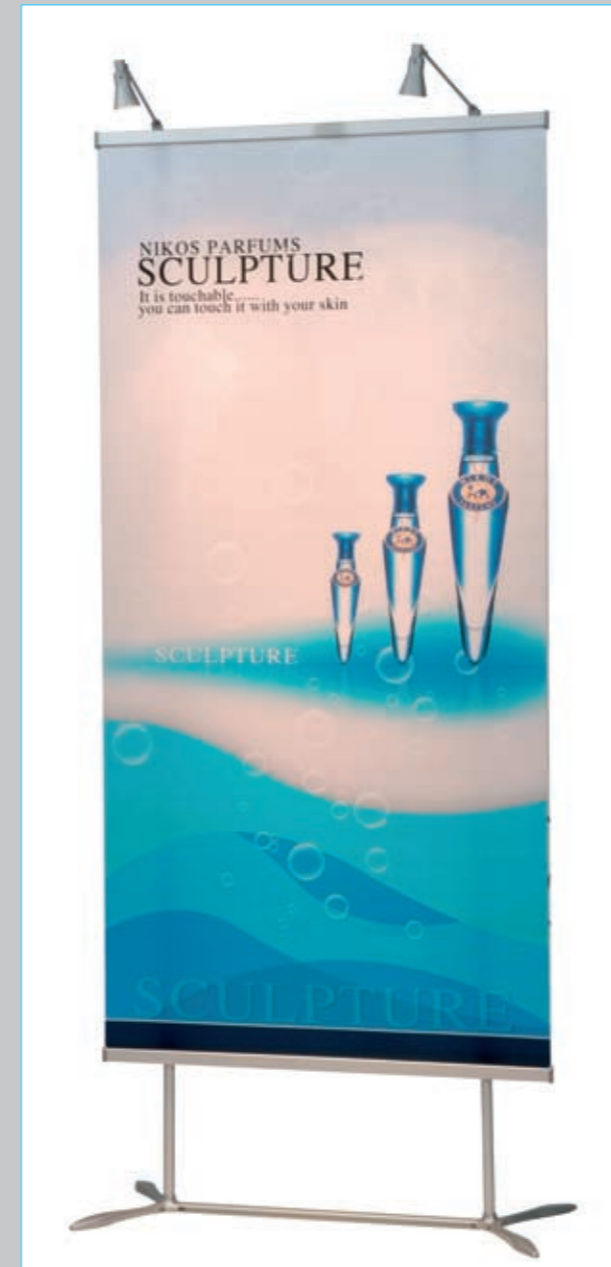

**BANNER STAND
"MIKOS LINE" TRIPLE SIDED**

Item No: MIK-1000/TR
Material: Aluminium
Color: Silver
Graphic size: 90cmWx200cmH (x3)
Packing: 1 pcs/ctn.

DISPLAY WALL "TRIPLET"

Item No: L-BAN-3SC
Product: 3L-Banners with magnetic attachment
N.W.: 8.2kg, G.W.: 8.7kg
Graphic size: 240cmWx200cmH
Spotlight - Optional

STRAIGHT OR CURVED
POSITION POSSIBLE

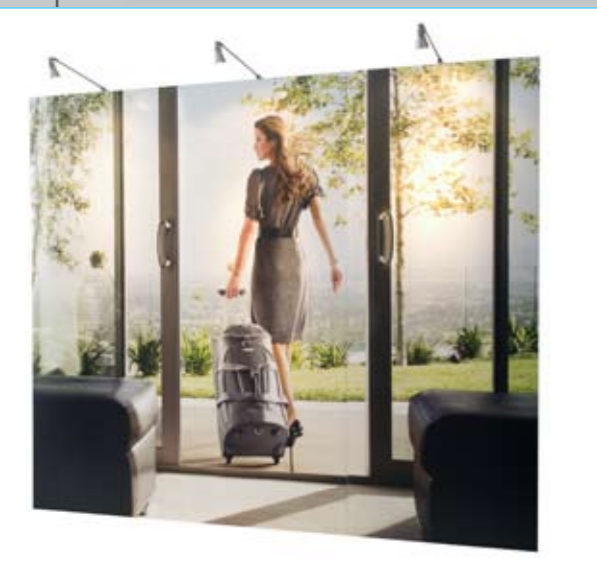
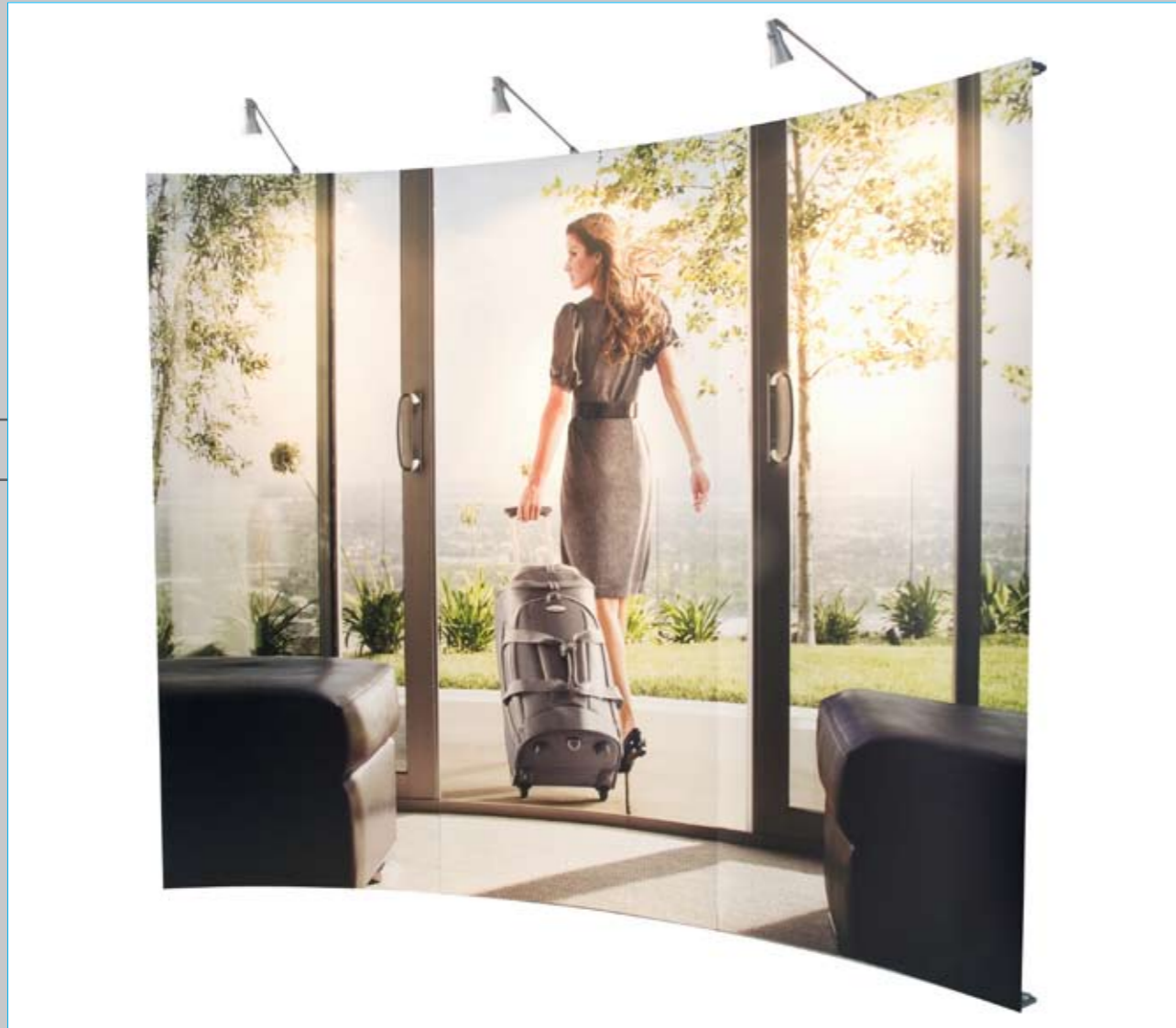

WALL PICTURE STAND

Item No: PW04060
Material: Aluminium/Fiberglass
Finish: Oxidative/Painting
Color: Silver/Black
N.W.: 1.00kg
G.W.: 1.25kg
Sizes: 60cmWx160cmH
60cmWx180cmH
80cmWx160cmH
80cmWx180cmH

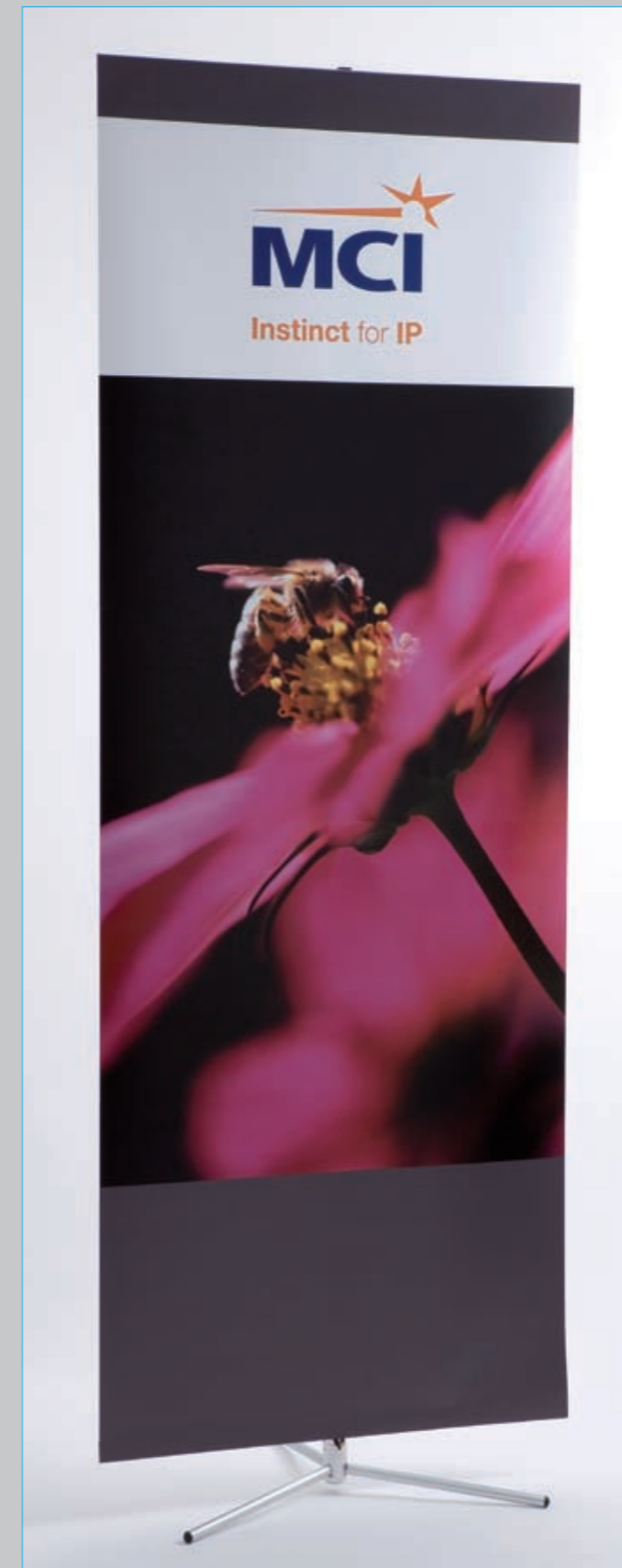

JUMBO BANNER 3M

System: Telescopic pole
Material: Aluminum
Graphic Size: Adjustable 100 to 300 cm
Width: 100 cm and 80 cm
G.W.: 4,5 kg

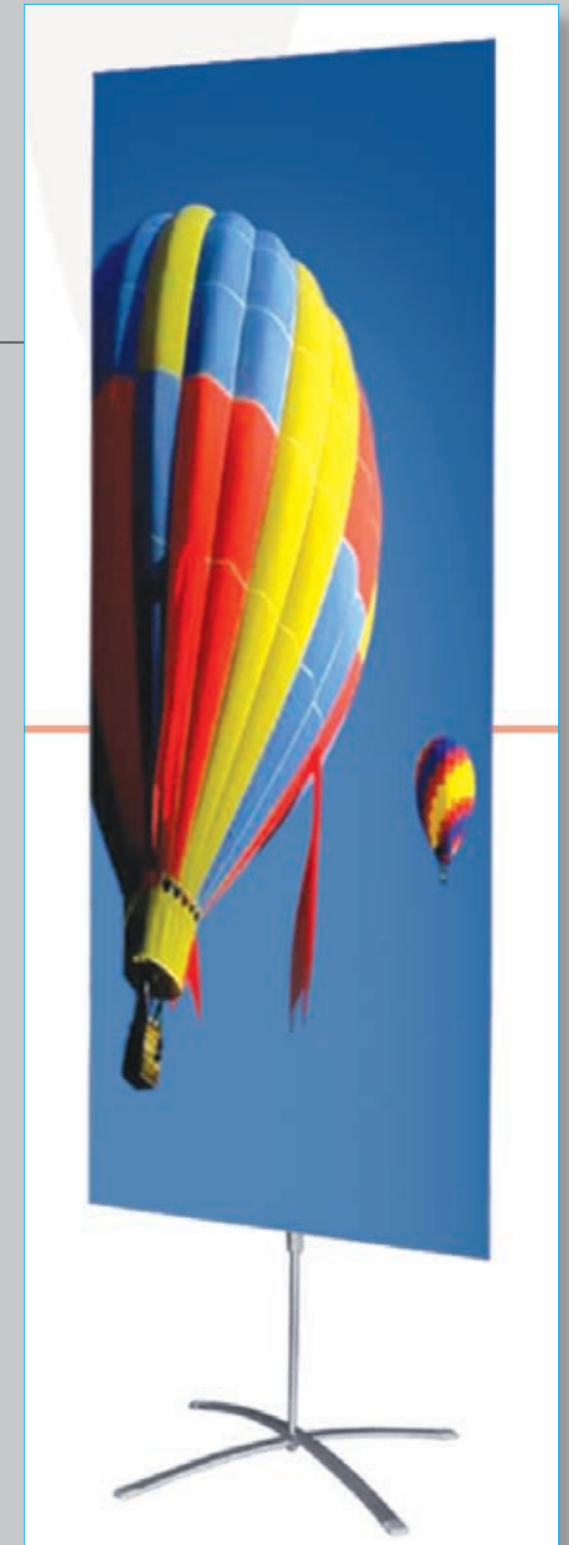

**DISPLAY WALL
"ARIZONA"**

Item No: DW-ARIZ/500
 Printing material: fabric
 Graphic size: 2862Wx2268mmH
 Spotlights - Optional



**BANNER STAND
"MIKOS LINE" TRIPLE SIDED**

Item No: MIK-1000/TR
 Material: Aluminium
 Color: Silver
 Graphic size: 90cmWx200cmH (x3)
 Packing: 1 pcs/ctn.

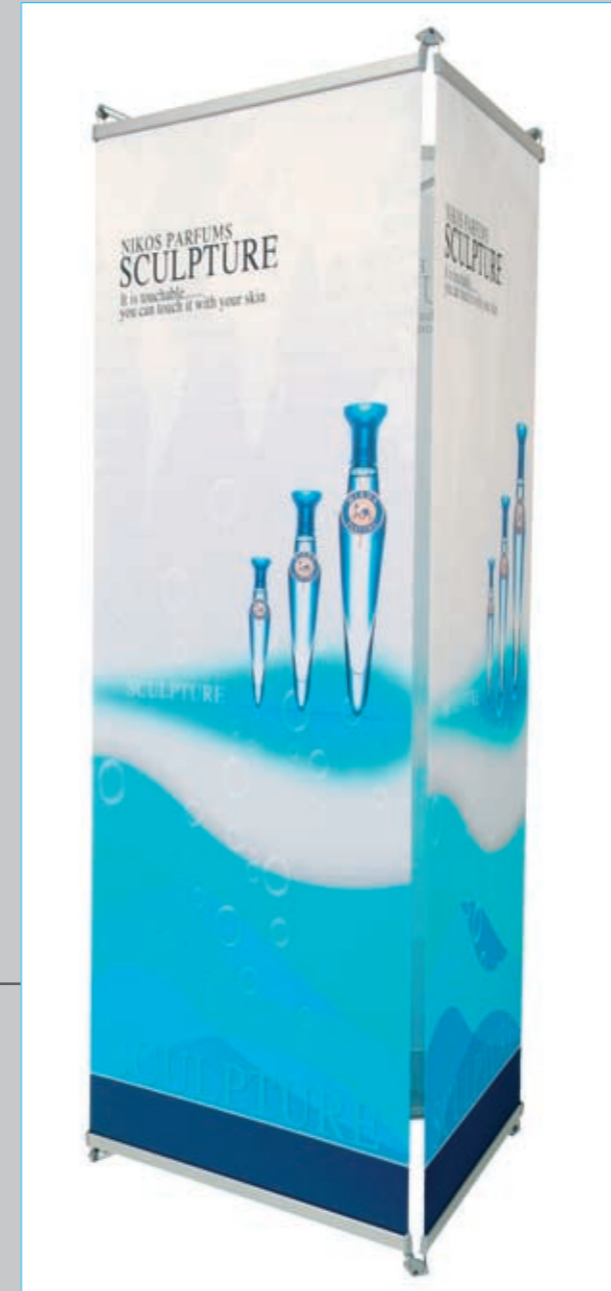

**BAMBOO BANNER STAND
"PANDA"**

Item No: BA-BAM-100
 Material: Bamboo Wood
 Size 1: 60cmWx180cmH
 Size 2: 80cmWx180cmH

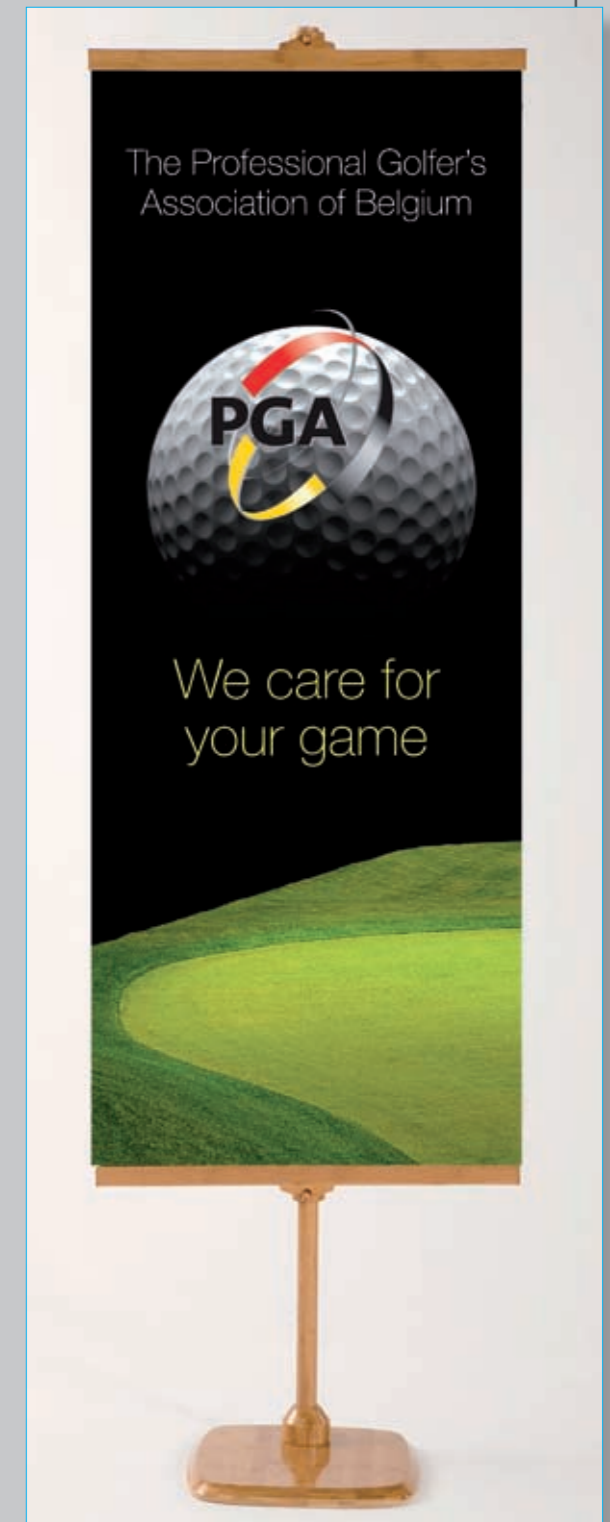

MAGIC BANNER STAND

Item No: PM01085
 Material: Aluminium/Fiberglass
 Finish: Oxidative/Painting
 Color: Silver/Black
 N.W.: 0.85kg
 Size: **ADJUSTABLE**
 88cmWx133cmH
 60cmWx200cmH



X-BANNER STAND

Item No: PX01085
 Material: Aluminium/Fiberglass
 Finish: Oxidative/Painting
 Color: Silver/Black
 N.W.: 1.80kg
 G.W.: 2.00kg
 Sizes:
 60cmWx160cmH
 120cmWx200cmH



ROLL UP BANNER STANDS

BA CLASSIC

Item No: BA75085
 Material: Aluminium & Steel
 Finish: Oxidative/Painting
 Color: Silver
 N.W.: 3.7Kg
 Sizes:
 BA00: 80cmWx200cmH
 BA01: 85cmWx200cmH
 BA02: 100cmWx200cmH
 BA03: 120cmWx200cmH

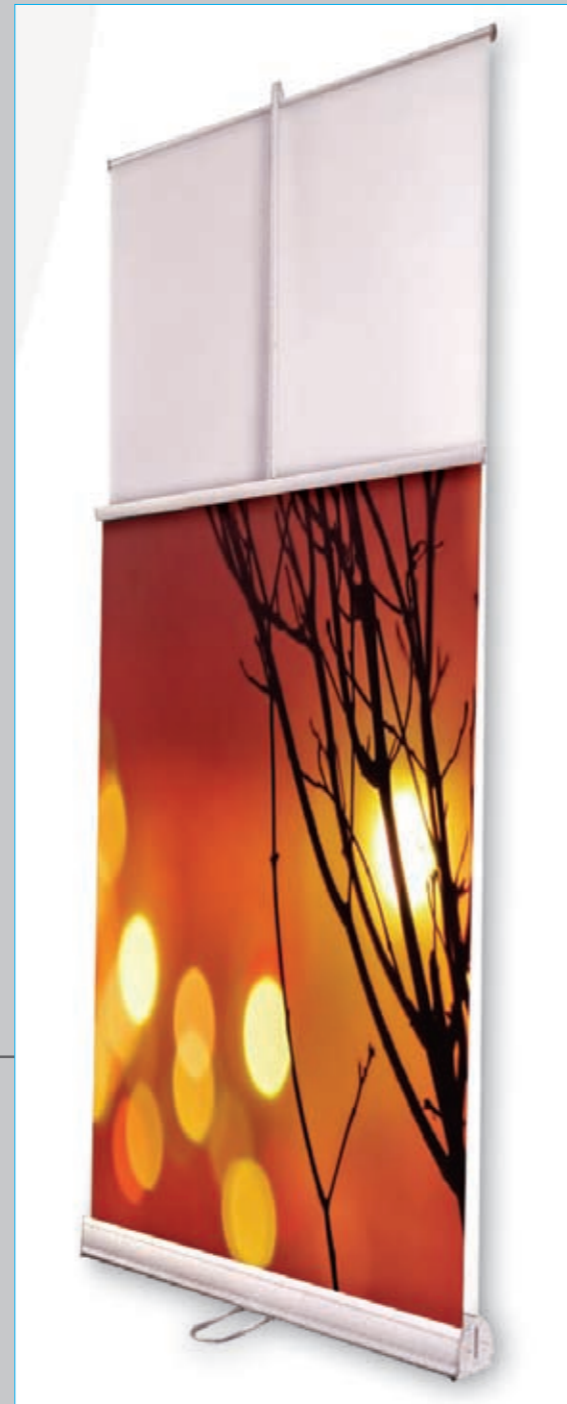

BA CLASSIC DOUBLE SIDED

Item No: BAD80085
 Material: Aluminium & Steel
 Finish: Oxidative/Painting
 Color: Silver
 N.W.: 6kg
 Sizes:
 BA01: 85cmWx200cmH
 BA02: 100cmWx200cmH

ELLIPTICAL BAMBOO ROLL UP

Item No: RU-BAM-85
 Material: Bamboo
 Packing: 6 pcs/ctn.
 Visible graphic size: 85cmWx194cmH

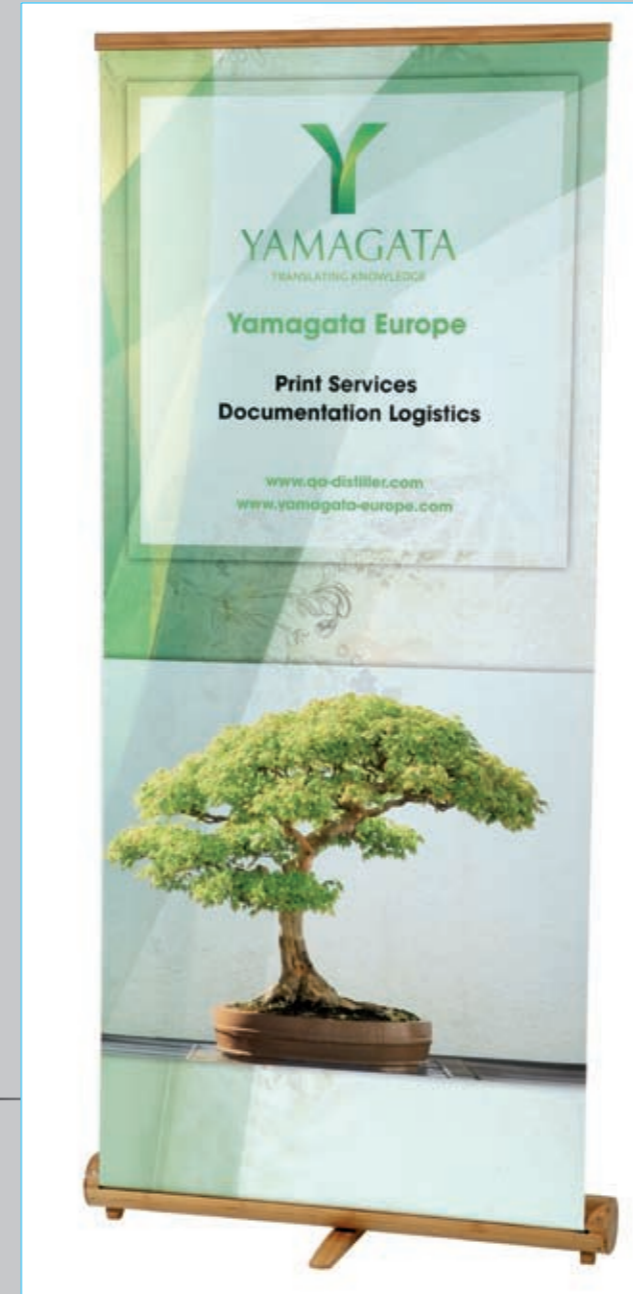

BA-DEL

Item No: BA-DEL
 Pole: Telescopic
 Material: Aluminium & steel
 Finish: Mat
 Color: Silver
 N.W.: 3.80kg
 Sizes:
 DEL00: 80cmWx200cmH
 DEL01: 85cmWx200cmH
 DEL02: 100cmWx200cmH
 DEL03: 120cmWx200cmH
 DEL04: 150cmWx200cmH



ROLL UP ADVERTISING RAILINGS



ROLL UP BANNER "OCEAN"

Item No: HK-23
 Pole: Telescopic
 Material: Aluminium & steel
 Finish: Mat
 Color: Silver
 N.W.: 10.30kg
 G.W.: 14.80kg
 Graphic sizes: 200cmWx(200-300)cmH



ROLL UP MODULAR PLUS

PRODUCT'S HIGHLIGHTS:

- Large advertising surface
- Very stable
- A modular system with numerous installation options

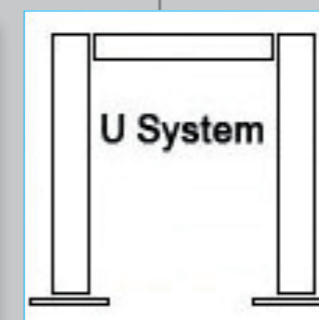
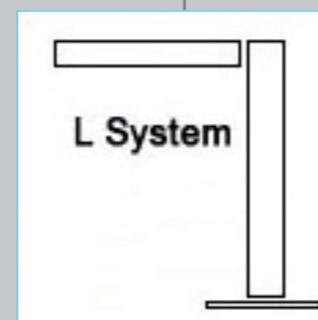

AVAILABLE SIZES

Size vertical telescopic poles: 100 - 150 - 200 cm
 Available sizes horizontal poles: 100 - 150 - 200 cm

ROLL UP BA-ZOL-N

Item No: BA-ZOL-N
 Material: Aluminium & Steel
 Finish: Matt Silver
 Sizes: 85cmWx200cmH
 100cmWx200cmH

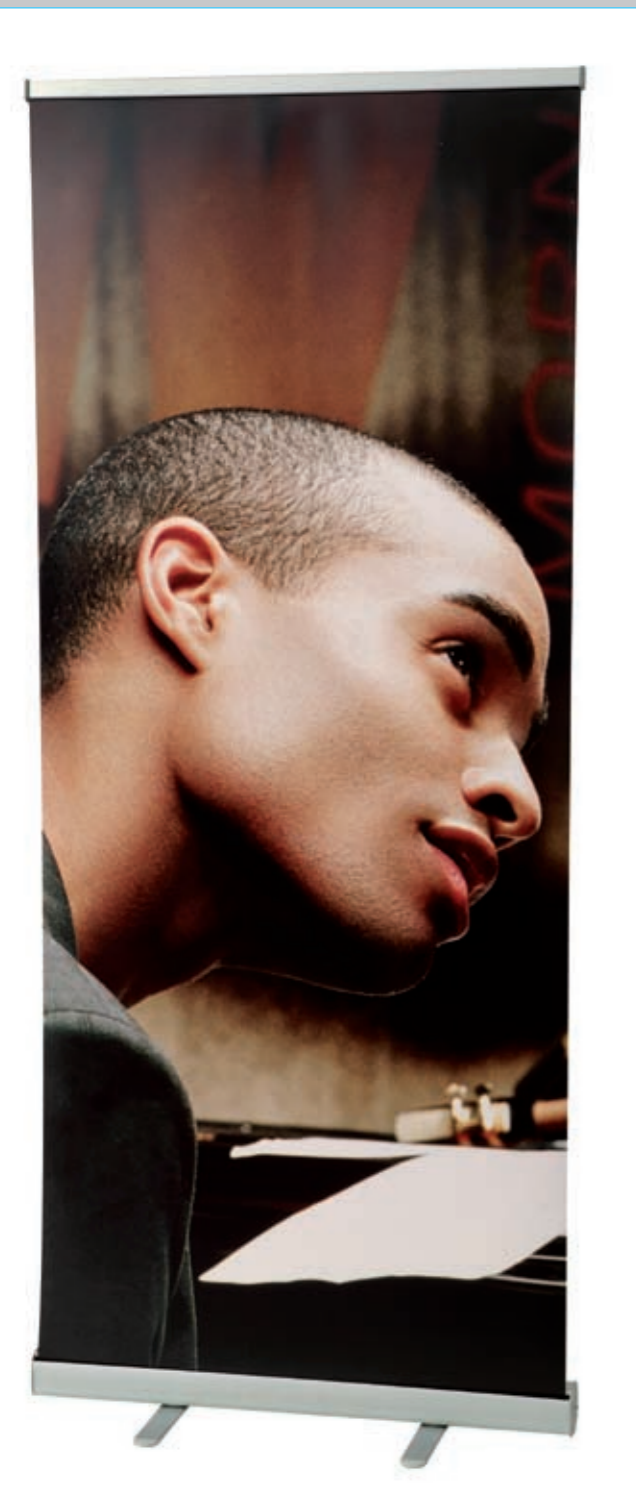

ROLL UP HK-1D

Item No: HK-1D
 Pole: Telescopic
 Material: Aluminium
 Color: Silver
 N.W.: 5.50kg
 G.W.: 6.50kg
 Size: 85cmWx200cmH
 100cmWx200cmH
 Banner spot: optional

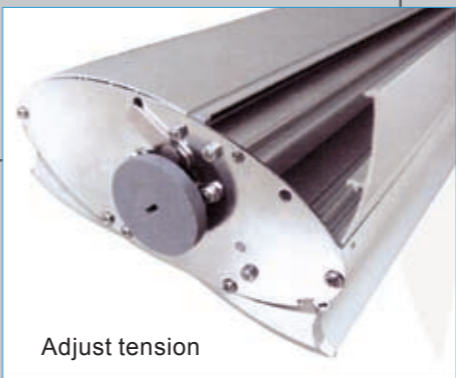

Adjust tension

SILVER WINGS HY-1D

Item No: HY-1D
 Pole: Telescopic
 Material: Aluminium
 Color: Silver/Black
 N.W.: 7.20kg
 G.W.: 31.3kg, 4 pcs Box
 Size: 85cmWx200cmH
 100cmWx200cmH
 Banner Spotlight - Optional



Snap roller, easy graphic change



SILVER WINGS HY-2

Item No: HY-2
 Material: Aluminium
 Color: Silver
 N.W.: 8.5kg
 G.W.: 36.5kg, 4 pcs Box
 Size: 85cmWx200cmH



ROLL UP "BA-DEL"
 Item No: BA-DEL-XL
 Material: Aluminium & steel
 Telescopic pole
 Graphic size: 150cmWx(160-220)cmH

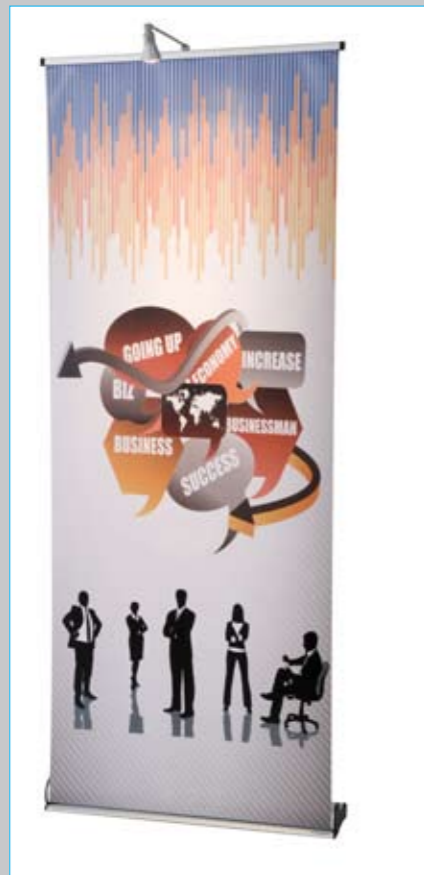

ROLL UP "CONNECTION" LINE
 Item No: RU-NEC/85
 Material: Aluminium & steel
 Full face display
 Join multiple units together
 Adjustable to any height range
 Graphic size: 85cmWx240cmH (max.)
 Spotlights: optional

ROLL UP "CONNECTION"
 Item No: RU-NEC / 85
 Full face display
 Pole: Telescopic
 Adjustable to any height range
 Graphic size: 85 x 240 cm.
 Optional: minispot



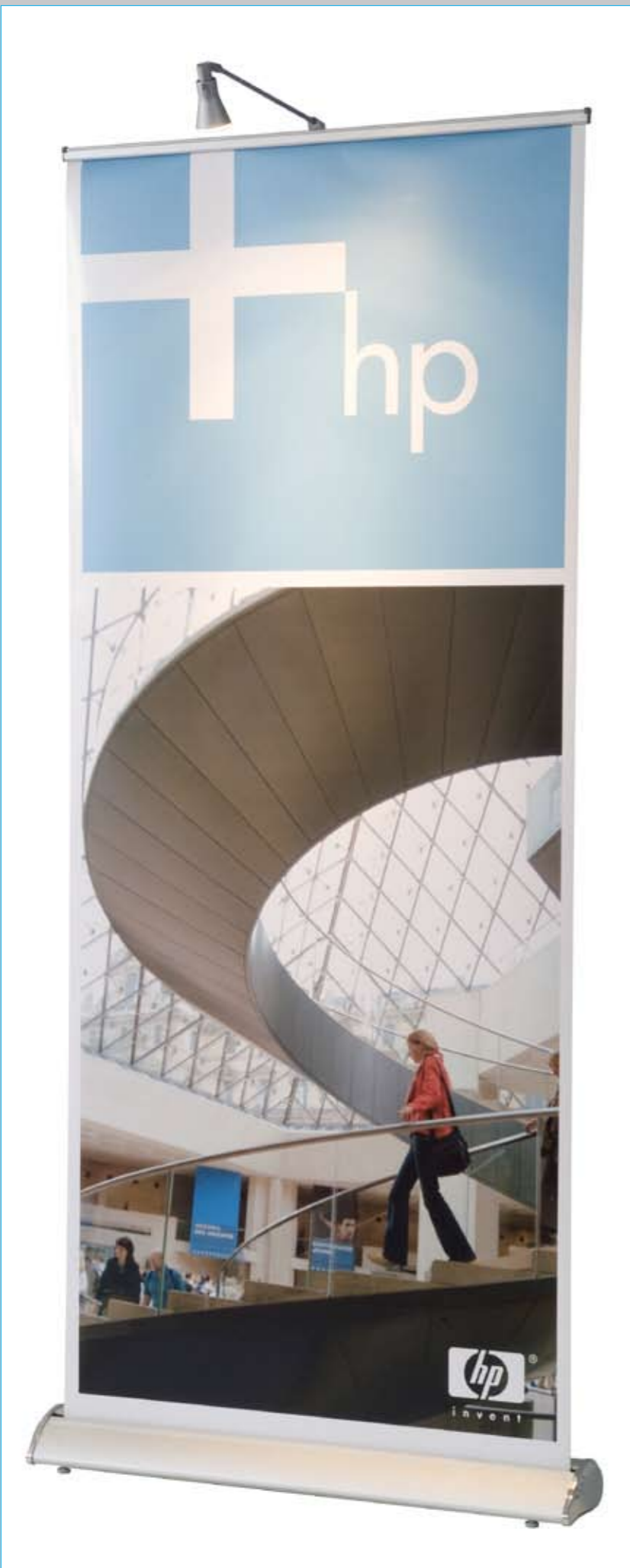

ROLL UP HK-3D

Item No: HK-3D
 Clip system in the base
 Telescopic pole
 Available sizes: 85cmWx200cmH
 100cmWx200cmH
 Spotlights: optional



ROLL UP "CONNECTION"

Item No: RU-NEC / 85

Full face display
 Pole: Telescopic
 Adjustable to any height range
 Graphic size: 85 x 240 cm.
 Optional: minispot



ONDULATO RU 500

Material: Aluminum
 Color: Silver
 Side Covers: Black transparent

G.W.: 5,45 kg
 N.W.: 23,2 kg
 QTY./Crtn: 4 pcs.
 Pole: Telescopic
 Graphic Size:
 85cmWx200cmH
 100cmWx200cmH

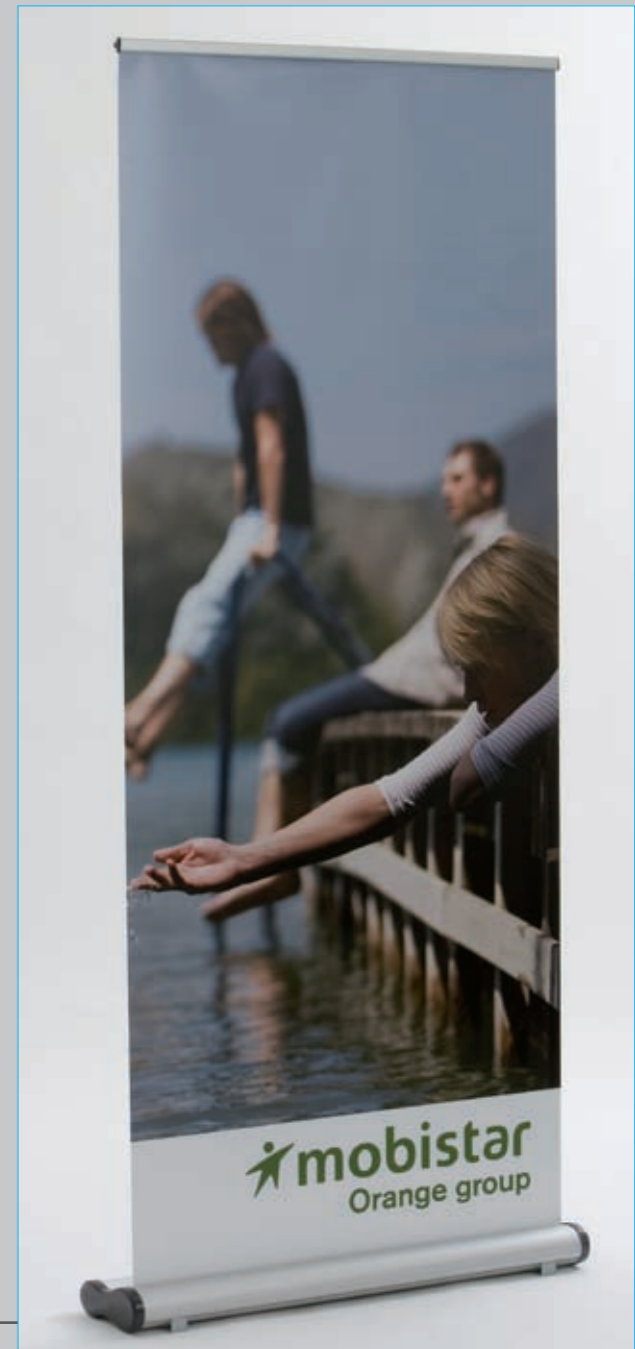

SCROLLING ROLL SCREEN HY-3

Item No: HY-3
 Material: Aluminium
 Color: Silver/Black
 N.W.: 7.2kg
 G.W.: 31.3kg, 4 pcs Box
 Size: 78cmWx407cmH

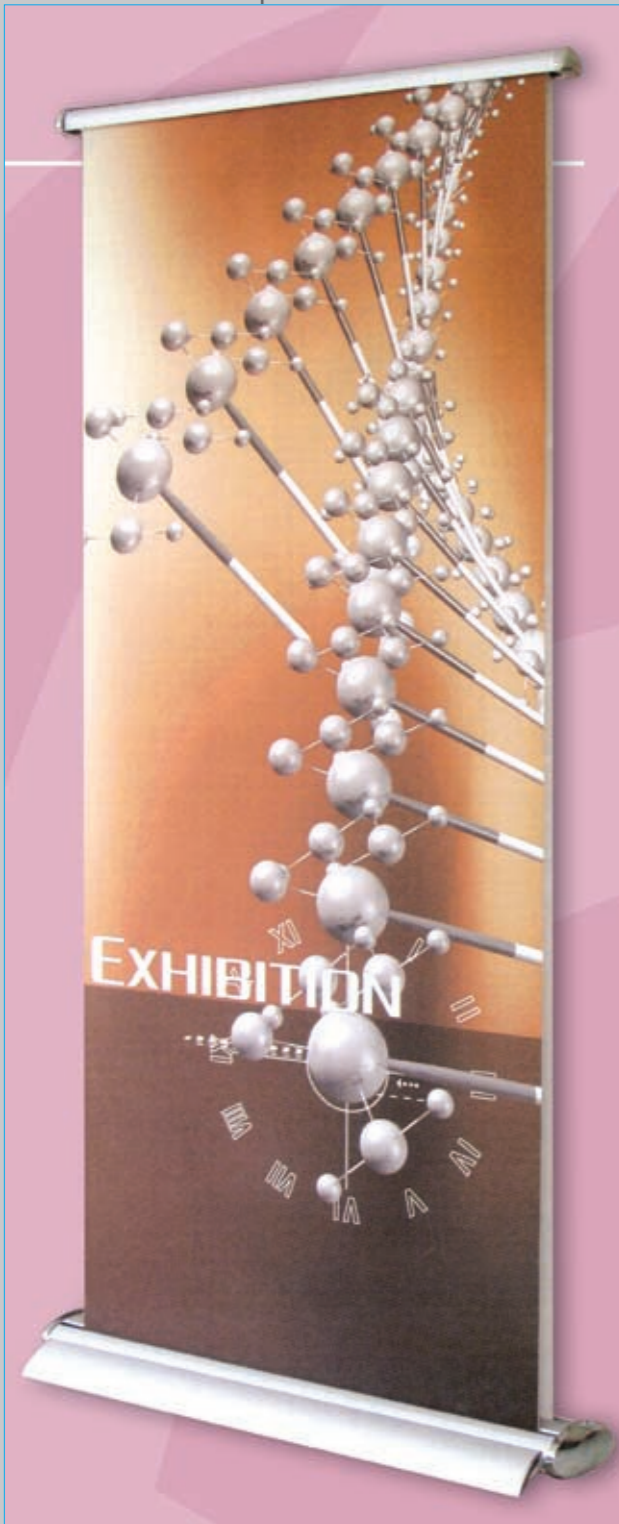

MAGICAL MEDIA MIRROR
 CHANGING FROM MEDIA TO MIRROR & FROM MIRROR TO MEDIA

Item No: MMM-PUB
 Material: Aluminium
 Light: Led
 Detecting distance of the mirror adjustable between 0 - 1,5m
 Printing material: regular back light film
 Graphic: easy changing pictures
 Power supply: 100v/240v
 Available sizes: A1 - A2 - A3 - A4

POSTER STANDS

POSTER BRACKET

ItemNo: PB45080
 Material: Aluminium, Steel
 Finish: Oxidative
 Color: Silver
 N.W.: 4.60kg
 Size: 145cmH

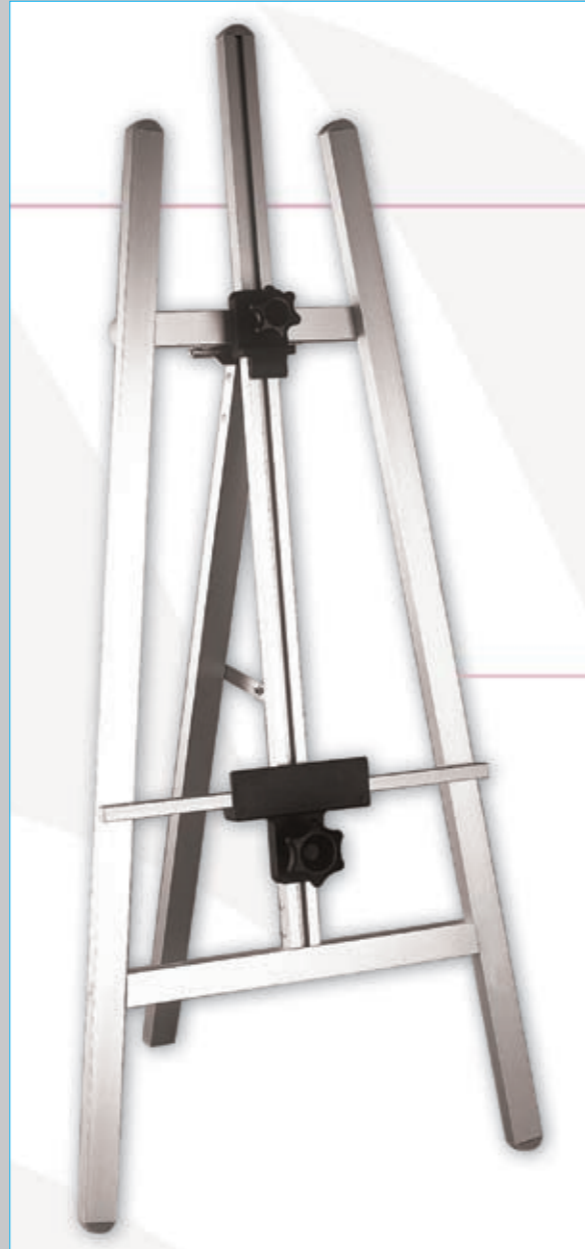

DOUBLE SIDED POSTER STAND

Item No: DSPS55080
 Material: Aluminium, Al-PE-Al
 Finish: Oxidative
 Color: Silver
 N.W.: 10kg
 G.W.: 10.80kg
 Size: 60cmWx80cmH



POSTER STAND YC-15

Item No: YC-15
 Material: Aluminium
 Finish: Oxidative/Painting
 Color: Silver
 N.W.: 16.00kg G.W: 18.00kg
 Size: A1



POSTER STAND A-STYLE

Item No: SP40080
 Material: Aluminium, Steel
 Finish: Oxidative/Painting
 Color: Silver
 N.W.: 7.00kg
 G.W.: 8.50kg
 Size: A1

HANGING POSTER BOARD

Item No: SH20090
 Material: Aluminium, Steel
 Finish: Oxidative/Painting
 Color: Silver
 Size: A1/A2/A3/A4

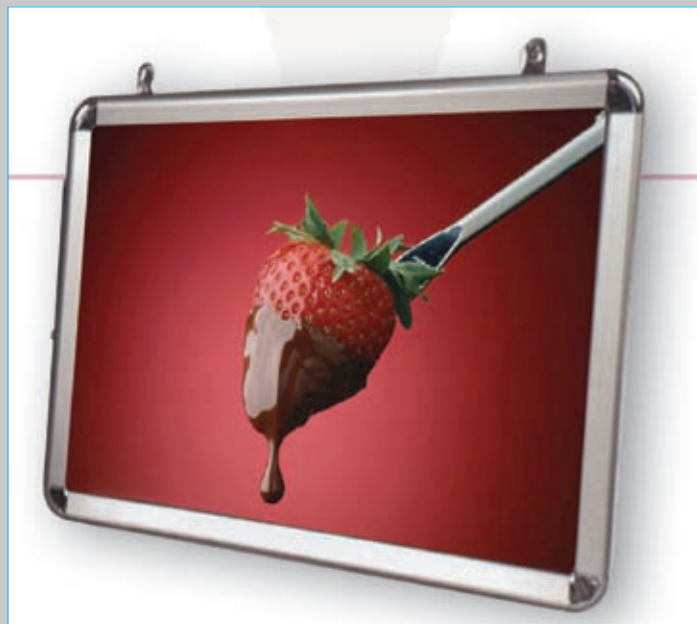

LIGHT BOX

Item No: SL34415
Material: Aluminium, Steel
Finish: Oxidative/Painting
Color: Silver/Black
N.W.: 5.20kg
G.W.: 5.90kg
Size: 160-180cmH



POSTER STAND C-STYLE

Item No: SP10080
Material: Aluminium, Steel
Finish: Oxidative/Painting
Color: Silver
N.W.: 5.00kg
G.W.: 5.50kg
Size: A3



SHELVES

LITERATURE STAND

Item No: LD-LST-AC
Material: Aluminium, acrylic
Size: A4

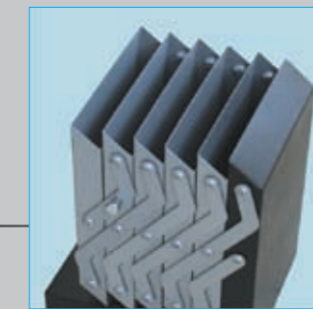

LITERATURE STAND

Item No: LD-LST-M
Material: Aluminium, steel
Size: A4

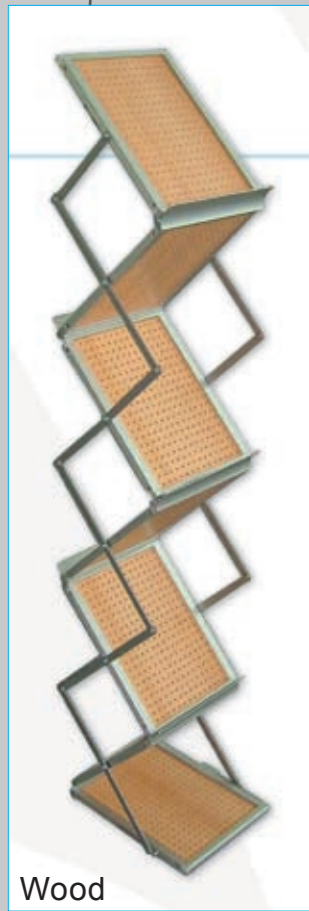

Wood

FOLDABLE CATALOGUE SHELF

Item No: SA06020
 Material: Aluminium, Steel
 Plates: Acrylic/Wood
 Finish: Oxidative
 Color: Silver
 N.W.: 5.50kg
 G.W.: 6.50kg
 Size: A4

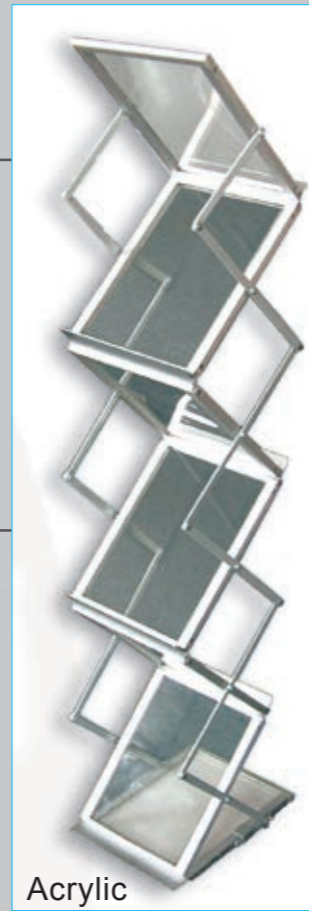
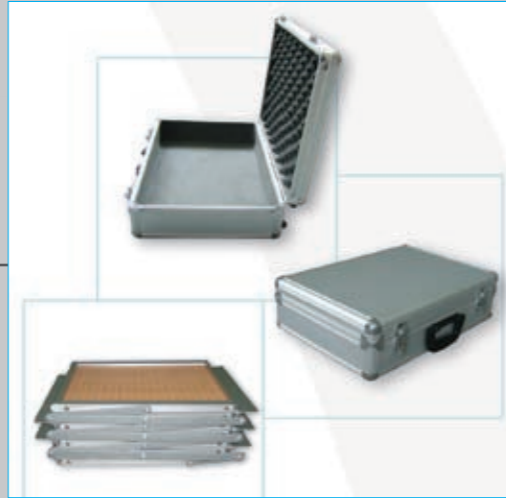

Acrylic

POCKET CATALOGUE SHELF SINGLE/DOUBLE

Item No: SB16020-S
 SB16020-D
 Material: Aluminium, Nylon
 Finish: Oxidative
 Color: Black
 N.W.: 10.00/14.00kg
 G.W.: 1.40/1.65kg
 Size: A4



Single



Double

BROCHURE HOLDER

Item No: BH-ACR (acrylic)
 BH-ABS (plastic)
 Material: Steel, Acrylic/ABS
 Finish: Chrome Plate
 Color: Shining
 N.W.: 5.40kg
 G.W.: 6.90kg
 Size: A4

PROFILES

SNAP PROFILE

Item No: Profile No 10
 Material: Oxygenated Aluminum
 Weight: 0.35 Kg/1 meter
 Standard size: 3.00 meter, 10 pcs/ctn

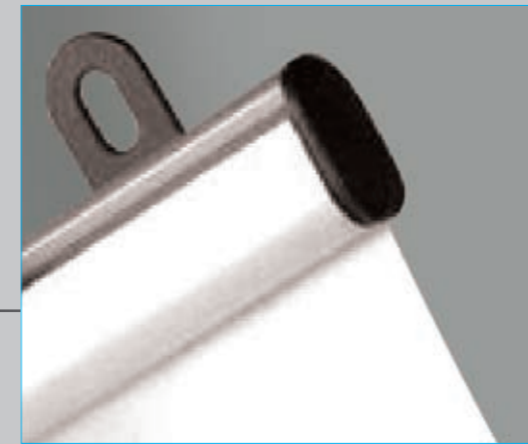

PROFILE 25

Item No: Profile N°25
 Material: oxygenated aluminium
 Weight.: 0,53kg/1meter
 Standard size: 3 meter
 Packing: 10 pcs/ctn.

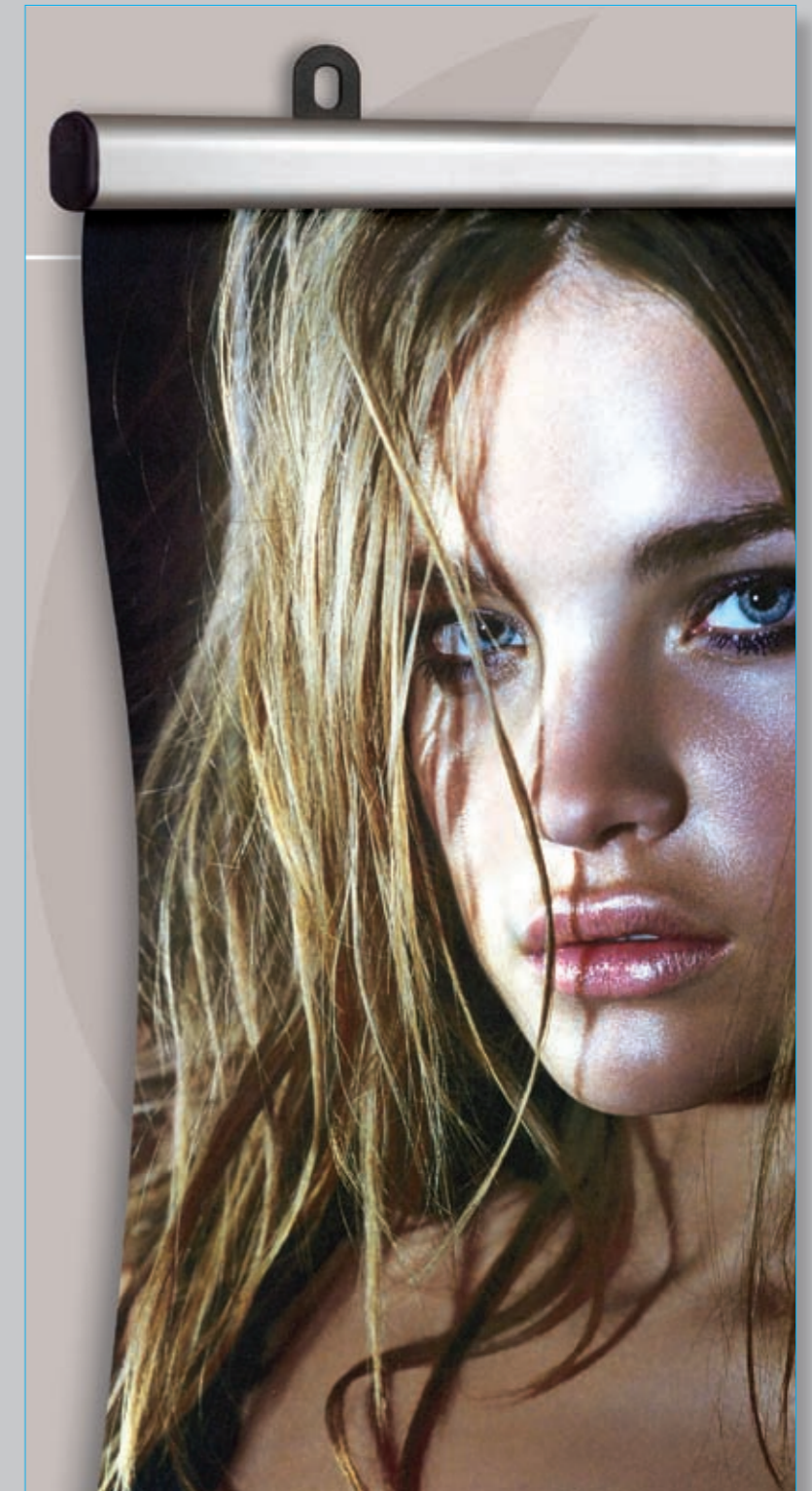

BAMBOO LINE

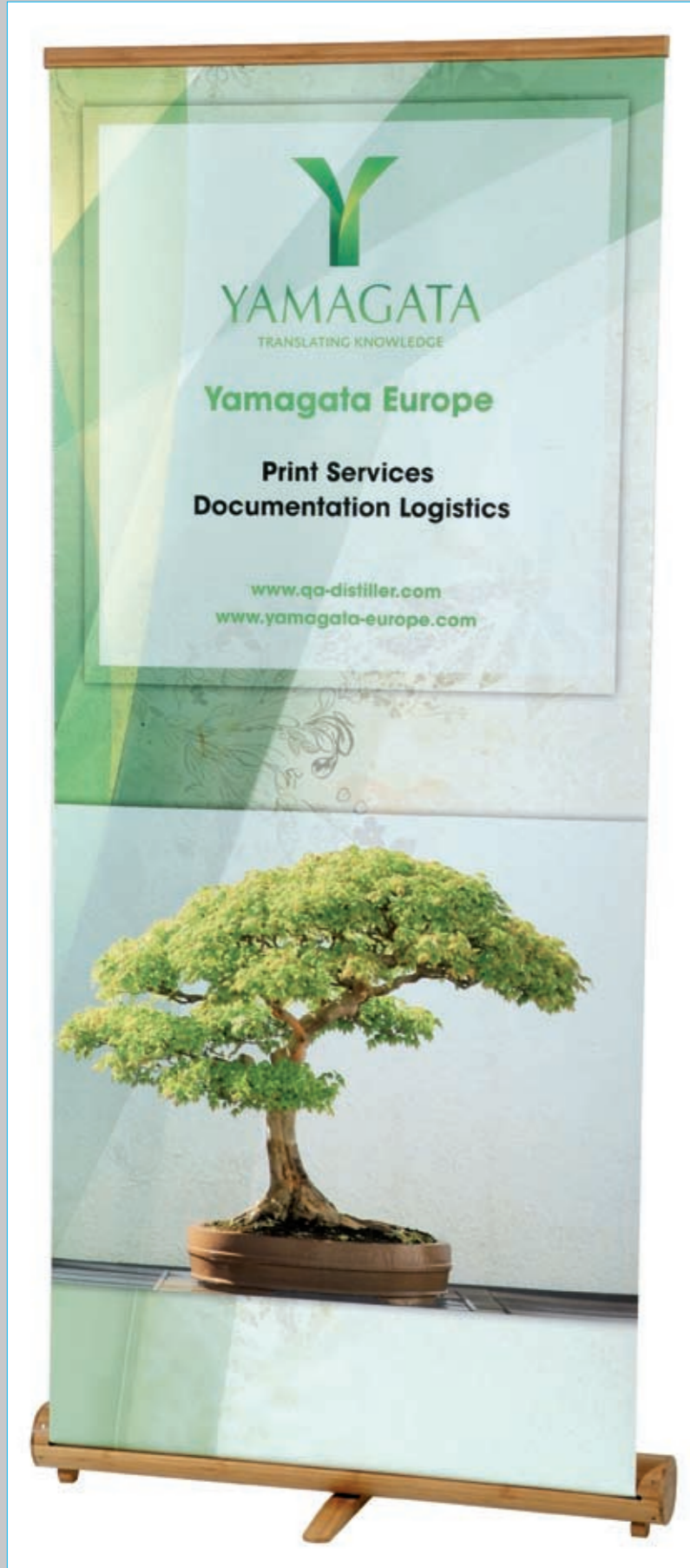

ELLIPTICAL BAMBOO ROLL UP

Item No: RU-BAM-85
 Material: Bamboo
 Packing: 6 pcs/ctn.
 Visible graphic size: 85cmWx194cmH



BAMBOO BANNER STAND "PANDA"

Item No: BA-BAM-100
 Material: Bamboo Wood
 Size 1: 60cmWx180cmH
 Size 2: 80cmWx180cmH

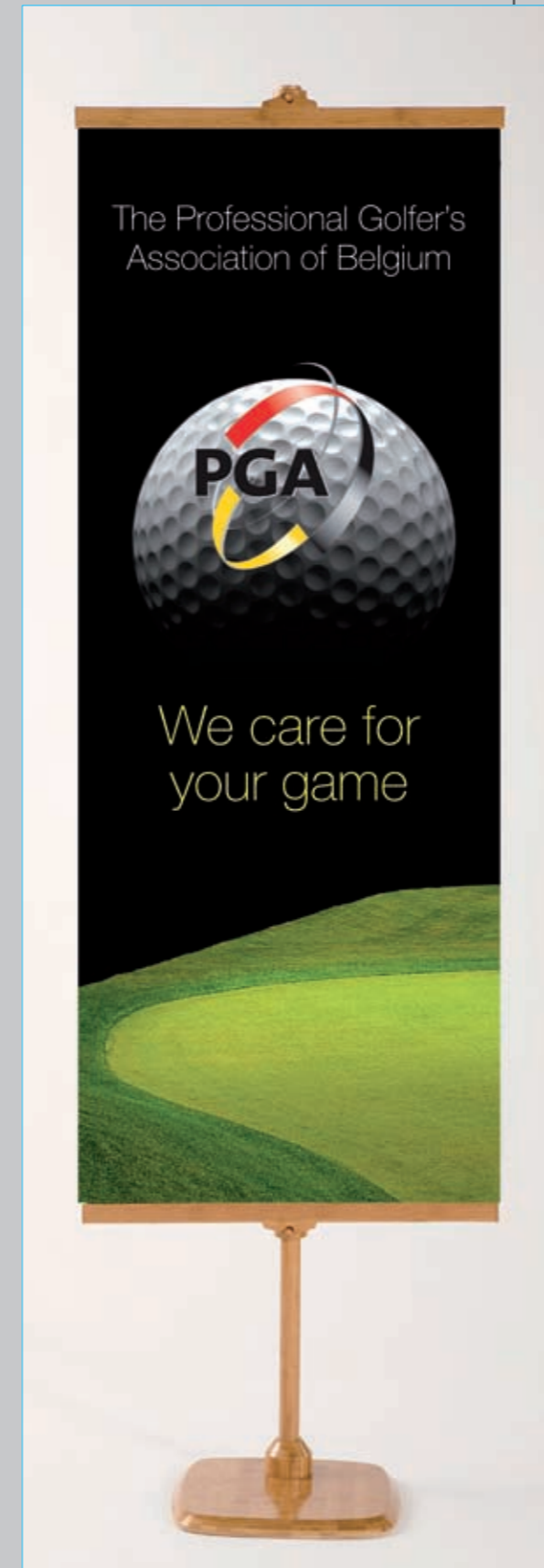

BAMBOO BANNER STAND "KOALA"

Item No: BA-BAM-K10/K30
 Material: Bamboo Wood
 Size KOALA 10: 50cmWx120cmH
 Size KOALA 30: 70cmWx175cmH



OUTDOORS



FLYING BANNER

Item No: DH-F-BS/M/L
 Material: Steel
 Color: Black
 N.W.: 1.6/1.8/2.0kg
 G.W.: 3.5/3.7/3.9kg
 Sizes: 255/342/453cm



FLEXY SWING 25

System: Double sided
 Base: Water base
 Material: Aluminum &
 Available sizes: A1
 A0
 70 x 100cm

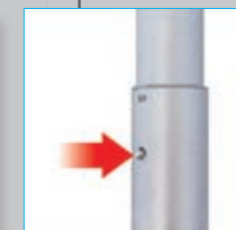

GIANT FLAGPOLE

Item No: FG50000
 Base: Water base
 Material: Aluminium, Plastic
 Color: Grey
 N.W.: 15kg
 Size: 500cmx108cm



OUTDOOR BANNER

Item No: YC-6
Base: Water base
Hooks: in metal
Color: Grey
N.W.: 2.9kg
G.W.: 8.3kg, 2pcs Box
Size: 60cmWx149 cmH

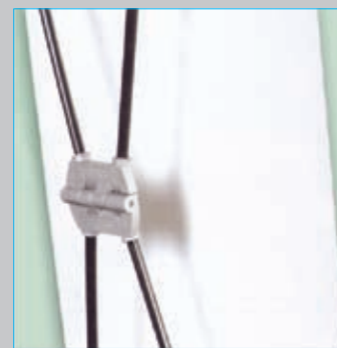
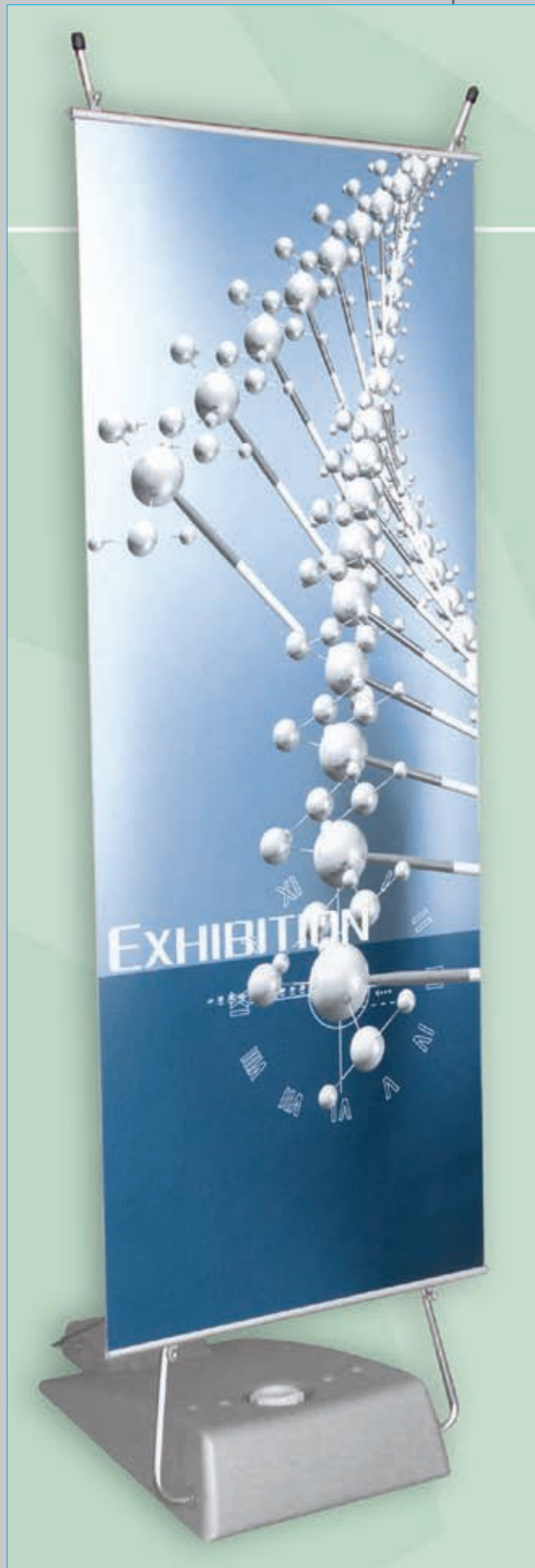

Please note that
this catalogue
will be regularly updated

...

Follow our internet
mailings attentively!

www.laskodisplays.com

POP UP SYSTEMS : SIZE/MEASURES

POP UP FLORENCE (3X3) CURVED

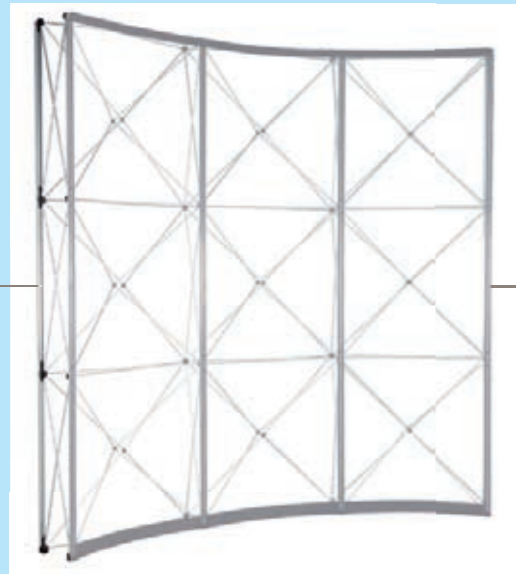

frame dimensions:

width 2700 mm
height 2380 mm
depth 630 mm

attention: important information
the magnetic tape is set 2 mm in from
the edge of your popup graphic panel.

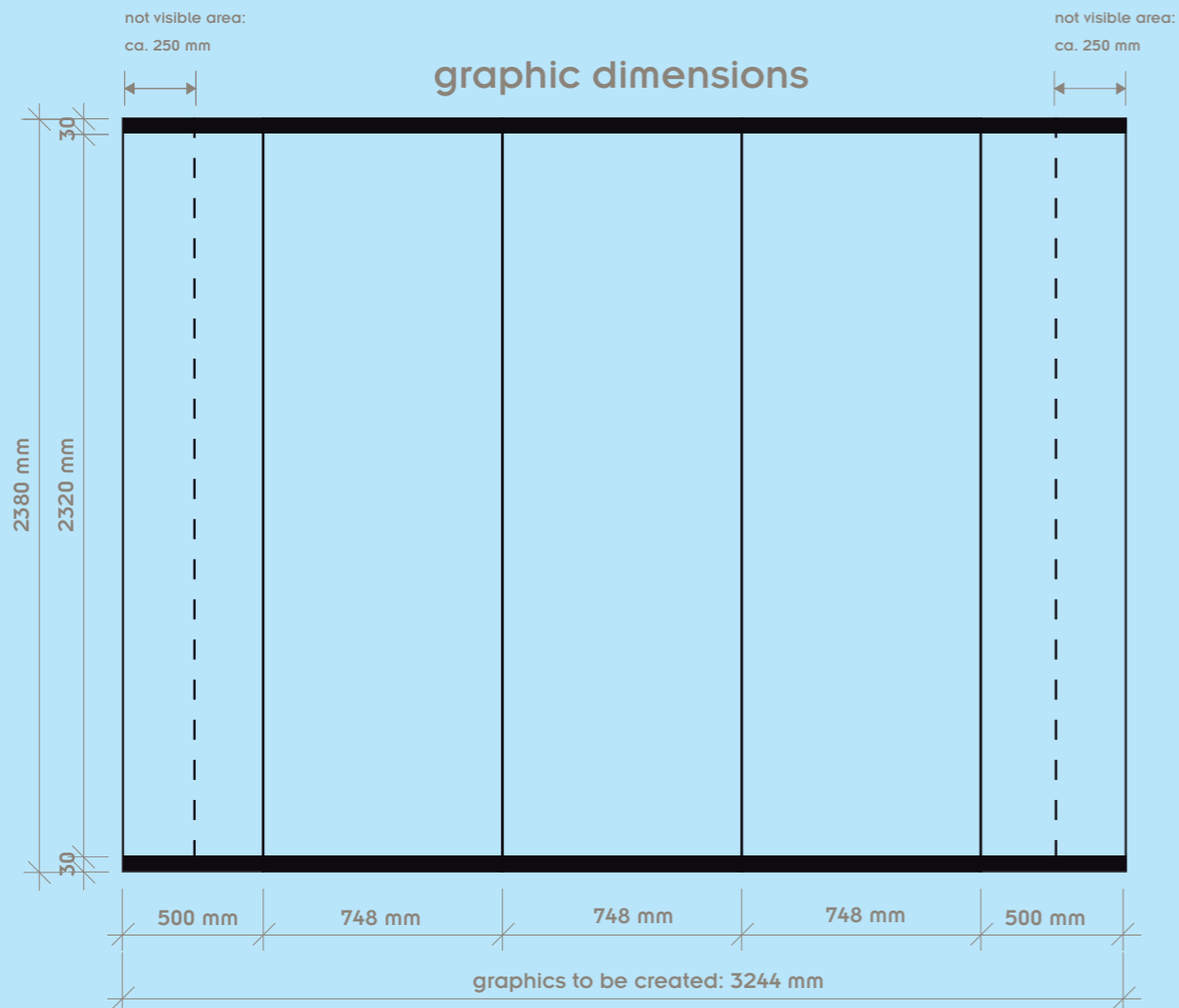

POP UP FLORENCE (4X3) CURVED

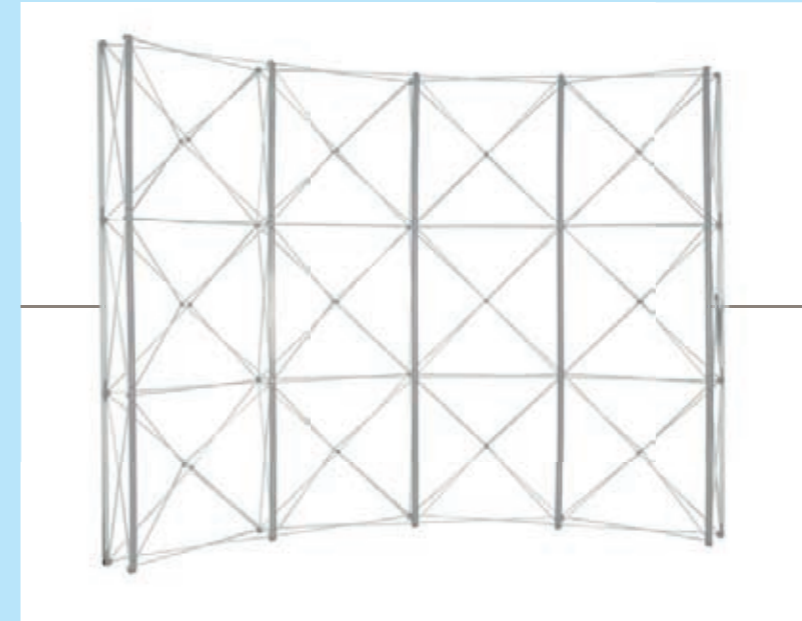

frame dimensions:

width 3300 mm
height 2380 mm
depth 900 mm

attention: important information
the magnetic tape is set 2 mm in from
the edge of your popup graphic panel.

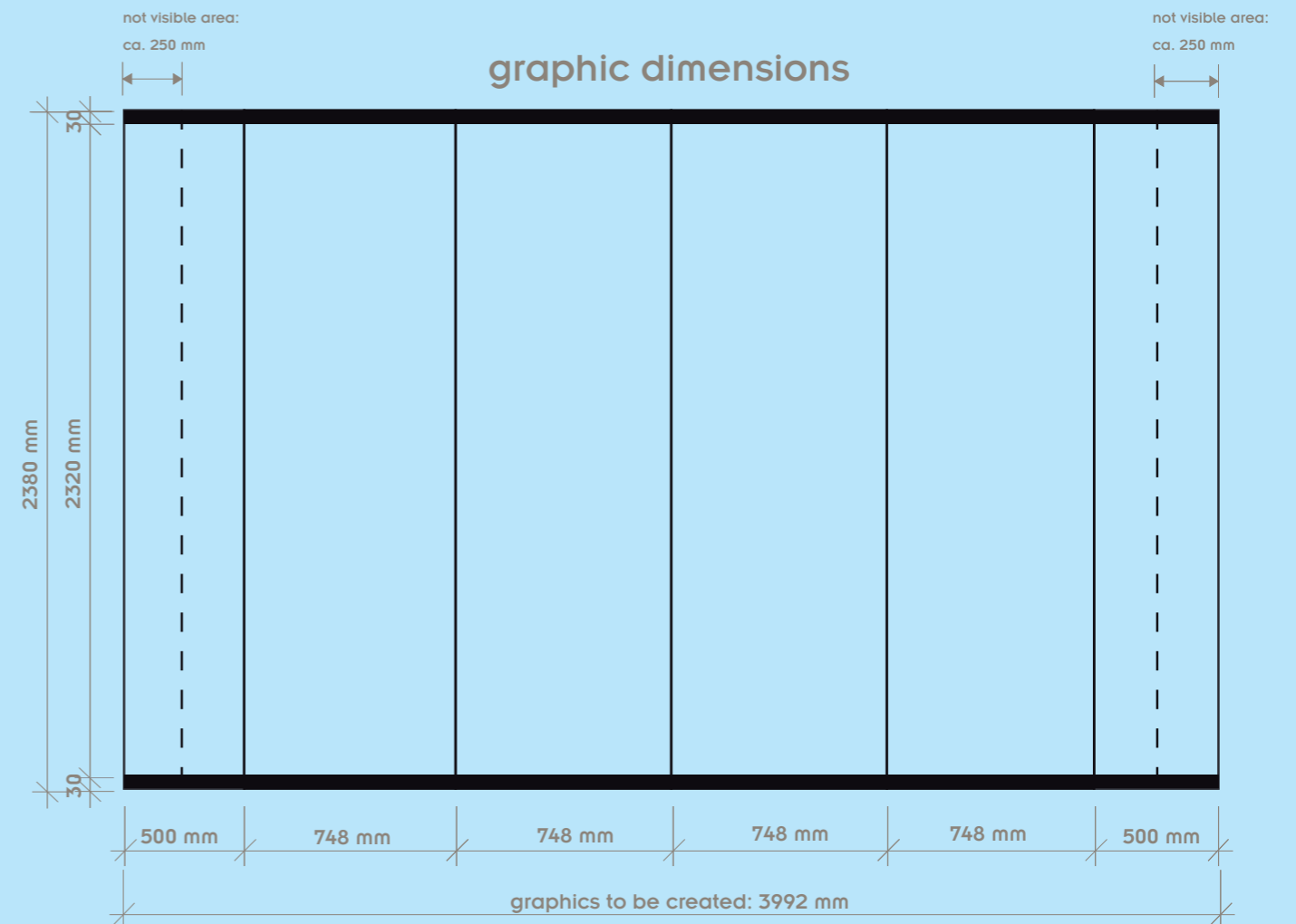

3X3 CURVED POP UP (3 FRONT+2 SIDE PANELS)

Printed Panels size

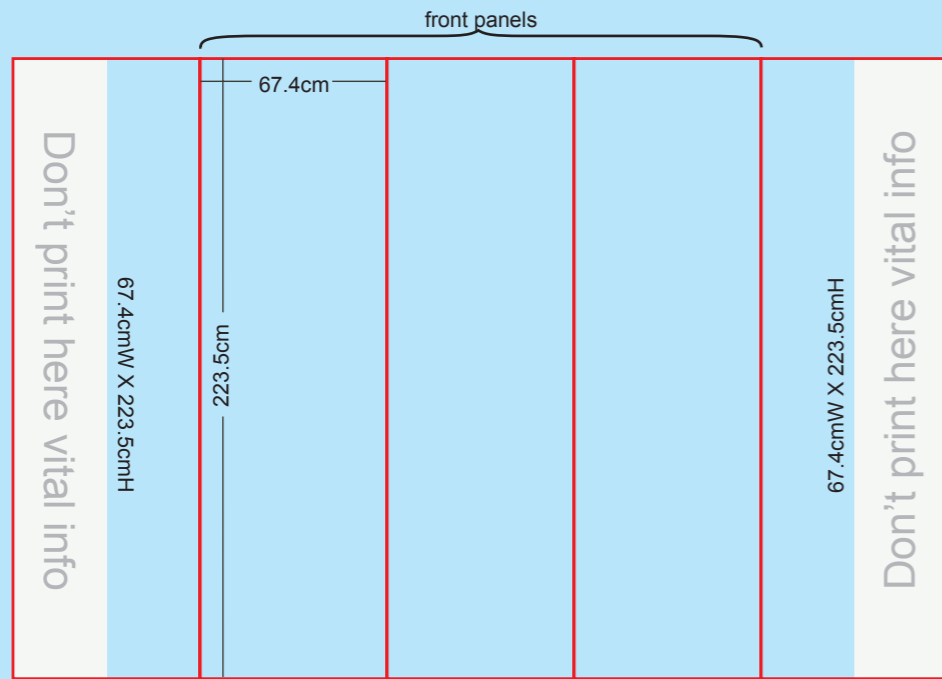

* Optional back panels: 80.8cmW X 223.5cmH

Measures of installed Pop Up including printed panels

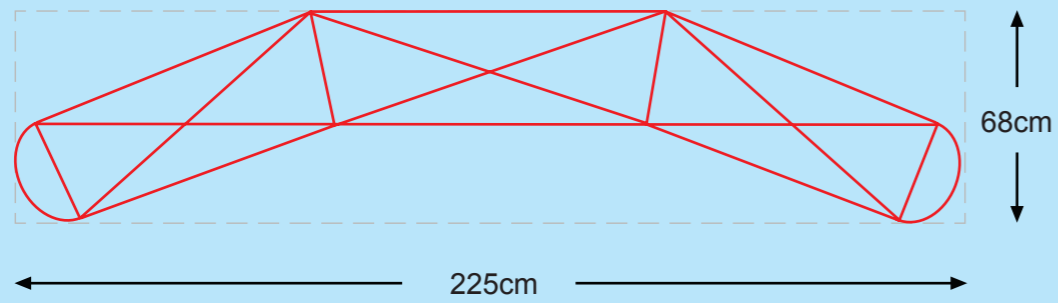

3X4 CURVED POP UP (4 FRONT+2 SIDE PANELS)

Printed Panels size

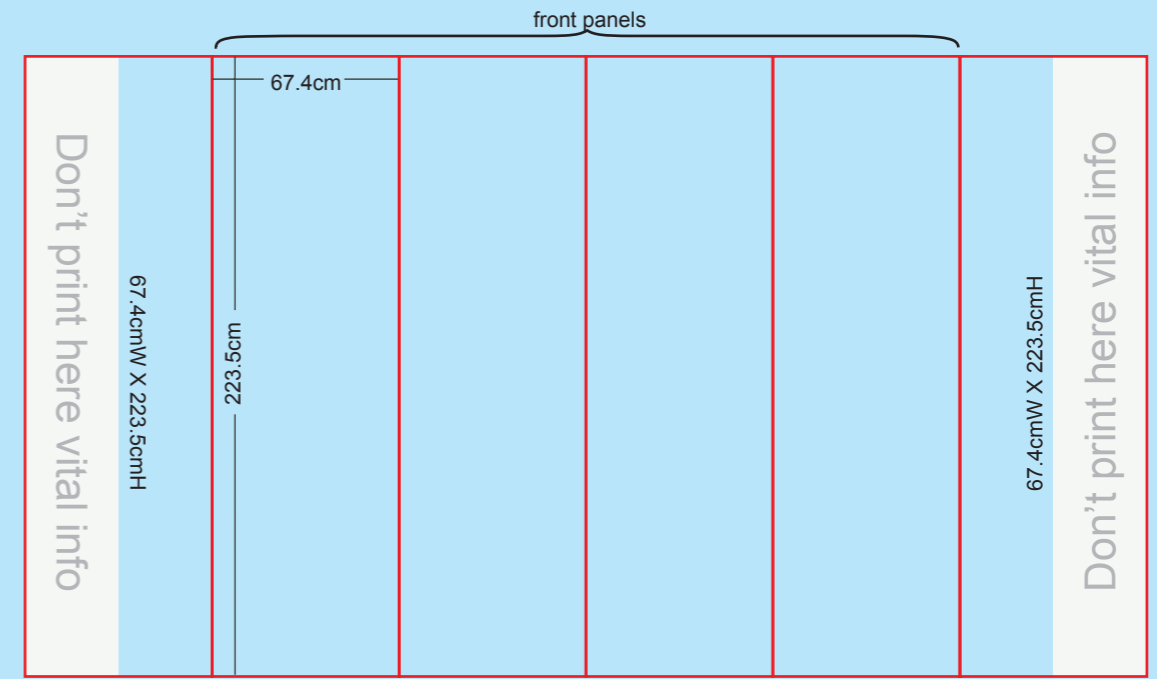

* Optional back panels: 80.8cmW X 223.5cmH

Measures of installed Pop Up including printed panels

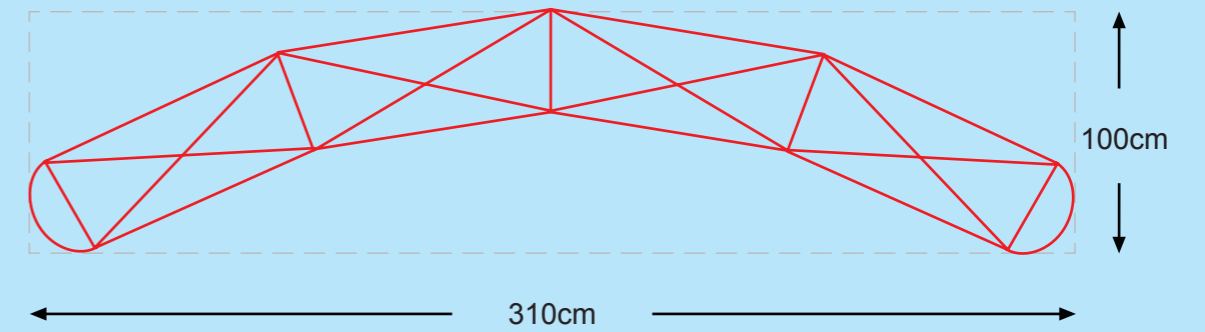

3X3 STRAIGHT POP UP (3 FRONT+2 SIDE PANELS)

Printed Panels size

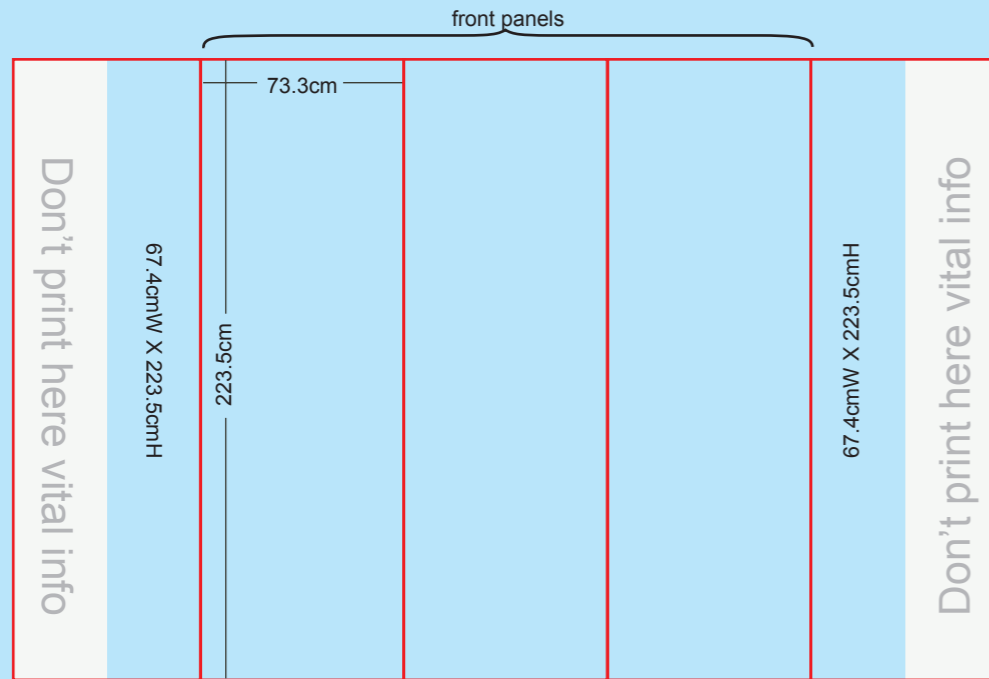

* Optional Back panels: 73.3cmW X 223.5cmH

3X4 STRAIGHT POP UP (4 FRONT+2 SIDE PANELS)

Printed Panels size

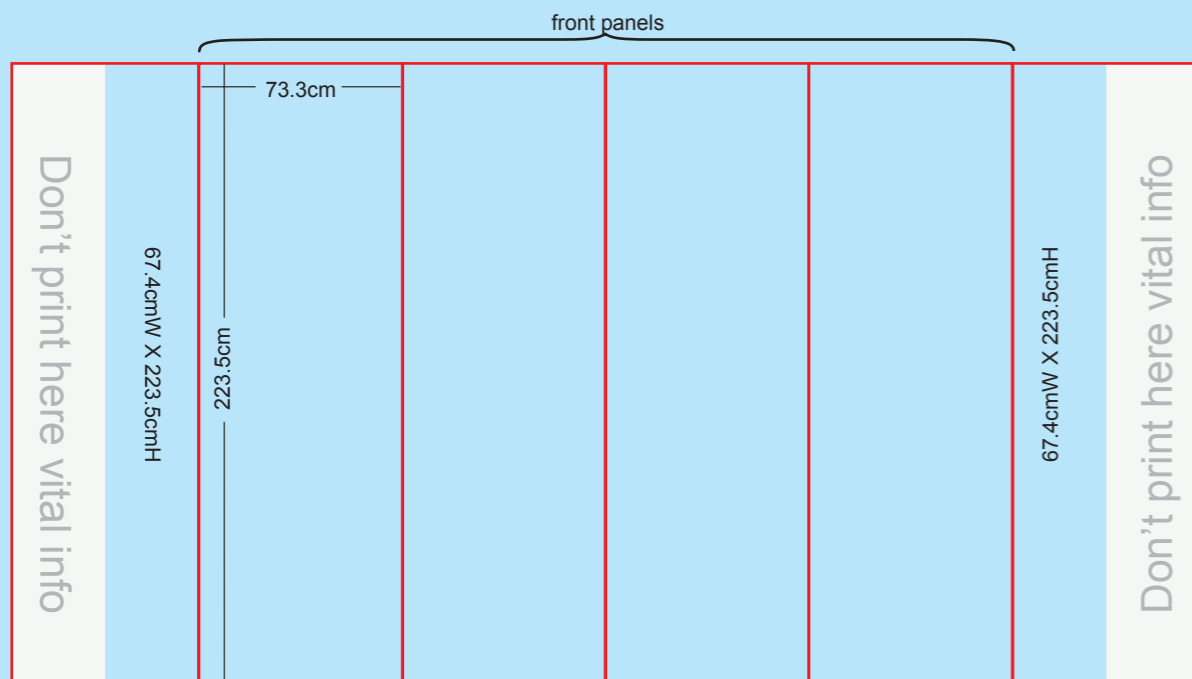

* Optional Back panels: 73.3cmW X 223.5cmH

HARD CASE TROLLEY : SIZE/MEASURES

HARD CASE TROLLEY TYPE B

Printed Panel measures for Hard Case Trolley

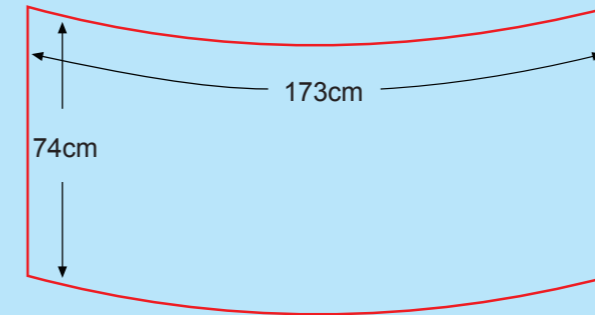

Wooden Top Measures

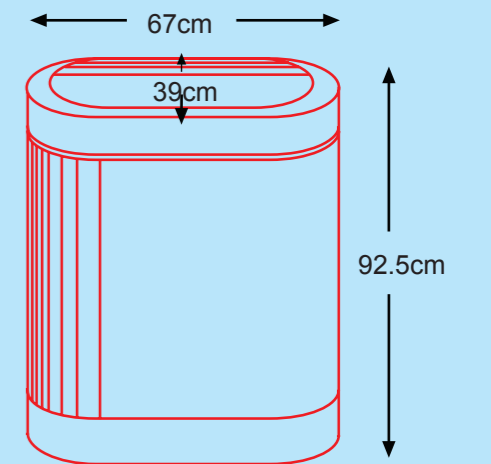
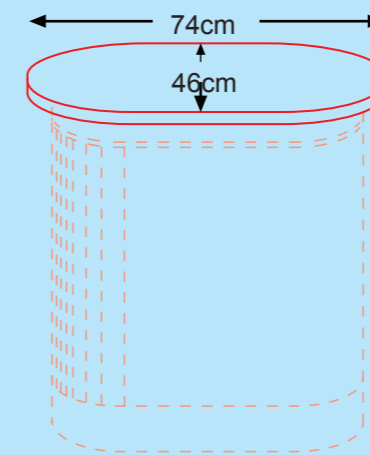

ROLL UP : SIZE/MEASURES

BA CLASSIC BAO1 - MEASURES FOR PRINT

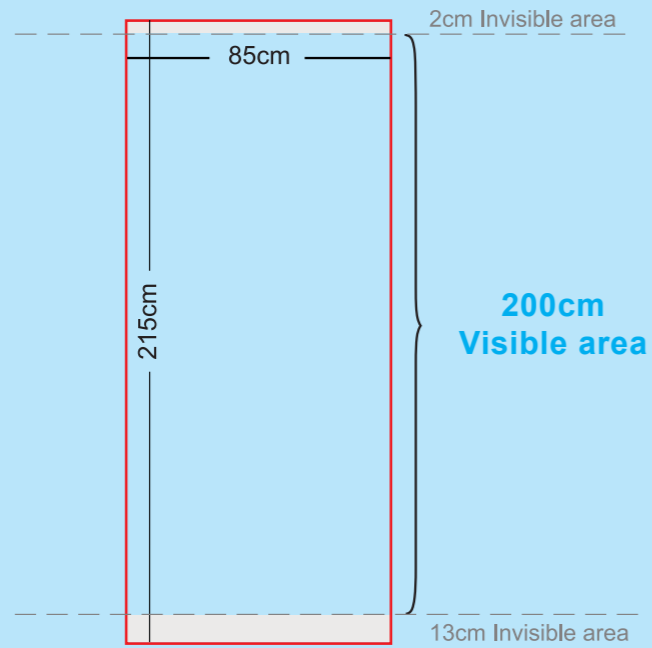

SILVER WINGS HY-1D MEASURES FOR PRINT

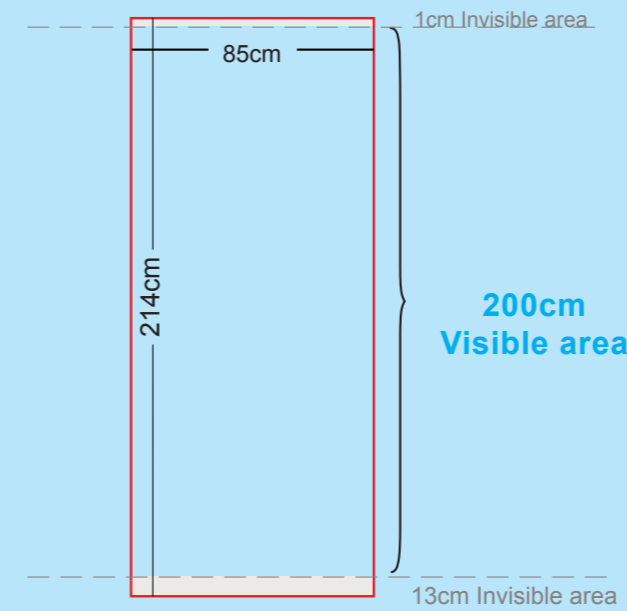

EXPAND STAND PE05085 MEASURES FOR PRINT

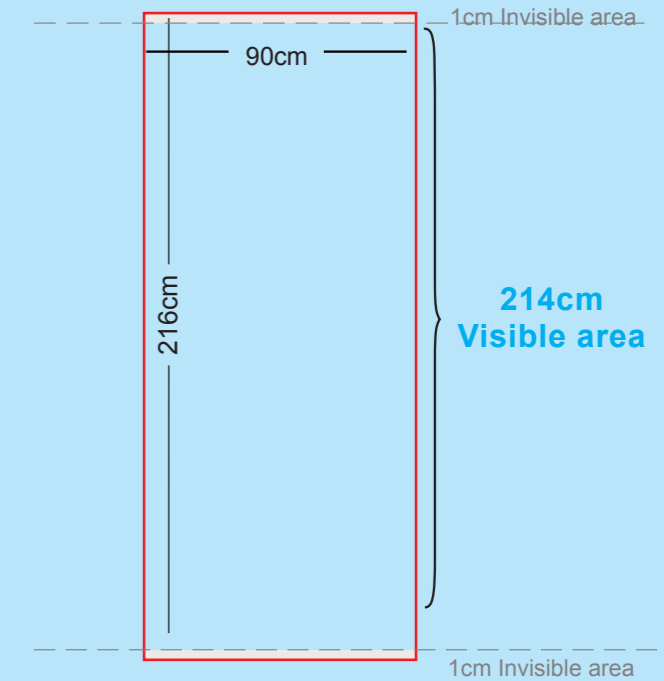

BA CLASSIC DOUBLE SIDED MEASURES FOR PRINT

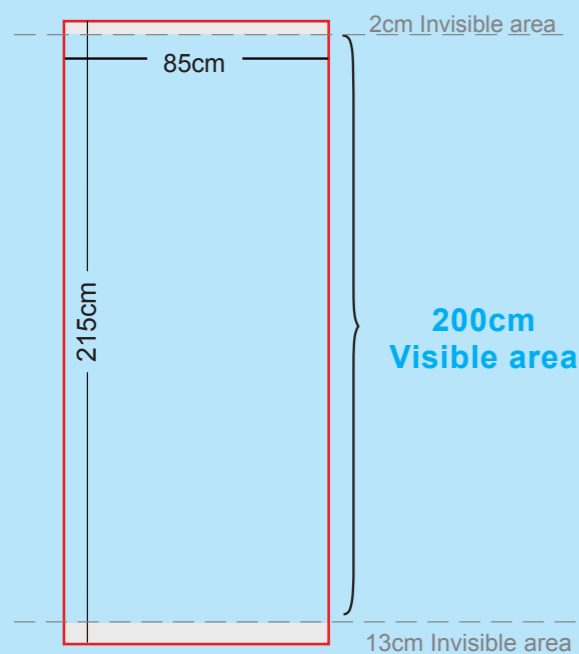

ROLL SCREEN HK-1D MEASURES FOR PRINT

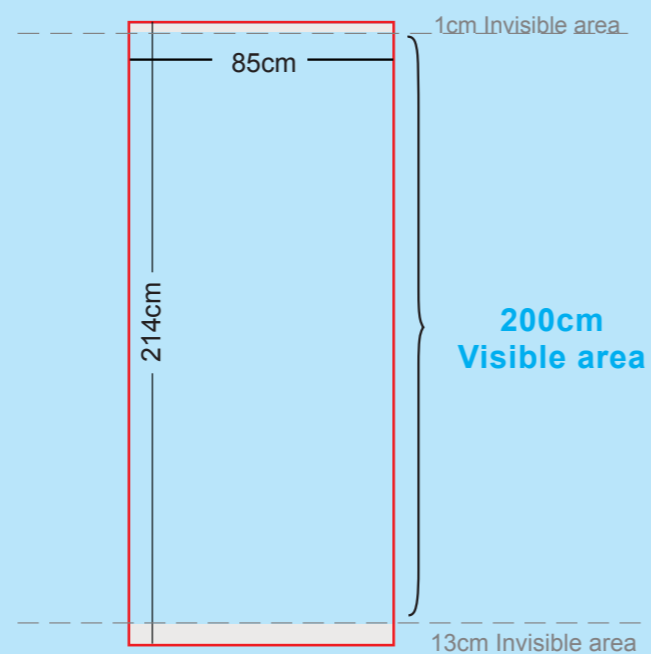

POP UP TABLE : SIZE/MEASURES

POP UP TABLE MEASURES

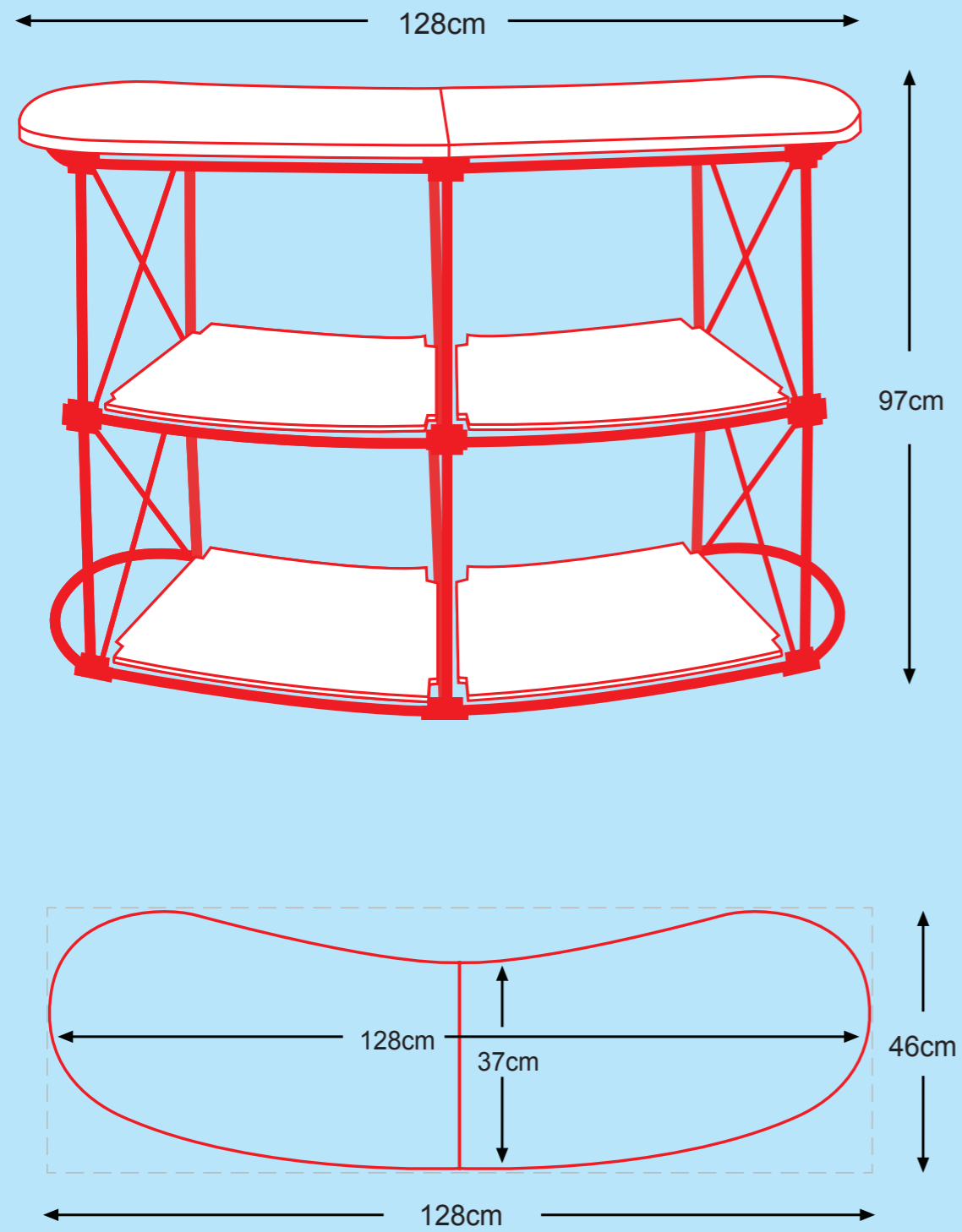

POP UP TABLE - PRINTED PANEL MEASURES

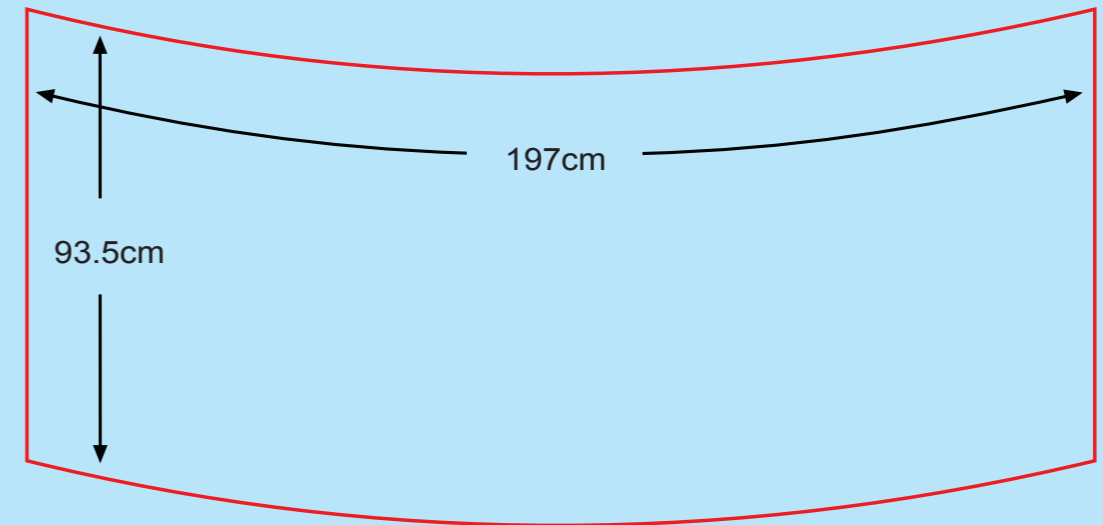

LASKO[©]

Displays International

Always one step ahead

www.laskodisplays.com

Five



**FAST
QUOTATIONS**

good



**BEST
PRICES**

reasons

STOCK

-

**FAST
DELIVERY**

to contact



**100%
QUALITY**

us

SAMPLES

-

**LARGE
DISCOUNT**